

HD-007/008 接插体

芯件适配 H3A 外壳

7+

8+

250V/50V 10A

外型尺寸 (mm)

外型尺寸 (mm)	订货号		型号	
	公接插件	母接插件		
<p>250V/10A</p> <p>接插针排序</p> <p>M: 31.7, 21.0</p> <p>F: 33.5, 21.0</p>	T 2 02 007 2101-000		HD-007-M	
		T 2 02 007 2201-000		HD-007-F
	T 2 02 008 2101-000		HD-008-M	
		T 2 02 008 2201-000		HD-008-F

插针

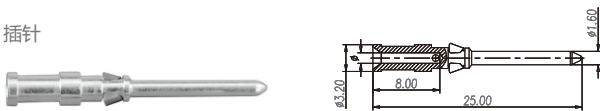

线规		剥线长度	镀银冷压接插针		镀金冷压接插针	
			型号	订货号	型号	订货号
0.14mm ²	AWG26-22	8.0mm	CDM-0.14	T 2 02 000 1002-000	DDM-0.14	T 2 02 001 1002-000
0.5mm ²	AWG20	8.0mm	CDM-0.5	T 2 02 000 1005-000	DDM-0.5	T 2 02 001 1005-000
0.75mm ²	AWG18	8.0mm	CDM-0.75	T 2 02 000 1008-000	DDM-0.75	T 2 02 001 1008-000
1.0mm ²	AWG18	8.0mm	CDM-1.0	T 2 02 000 1010-000	DDM-1.0	T 2 02 001 1010-000
1.5mm ²	AWG16	8.0mm	CDM-1.5	T 2 02 000 1015-000	DDM-1.5	T 2 02 001 1015-000
2.5mm ²	AWG14	6.0mm	CDM-2.5	T 2 02 000 1025-000	DDM-2.5	T 2 02 001 1025-000

Female



线规		剥线长度	镀银冷压接插针		镀金冷压接插针	
			型号	订货号	型号	订货号
0.14mm ²	AWG26-22	8.0mm	CDF-0.14	T 2 02 000 2002-000	DDF-0.14	T 2 02 001 2002-000
0.5mm ²	AWG20	8.0mm	CDF-0.5	T 2 02 000 2005-000	DDF-0.5	T 2 02 001 2005-000
0.75mm ²	AWG18	8.0mm	CDF-0.75	T 2 02 000 2008-000	DDF-0.75	T 2 02 001 2008-000
1.0mm ²	AWG18	8.0mm	CDF-1.0	T 2 02 000 2010-000	DDF-1.0	T 2 02 001 2010-000
1.5mm ²	AWG16	8.0mm	CDF-1.5	T 2 02 000 2015-000	DDF-1.5	T 2 02 001 2015-000
2.5mm ²	AWG14	6.0mm	CDF-2.5	T 2 02 000 2025-000	DDF-2.5	T 2 02 001 2025-000







H3A 金属外壳

表面粉末镀层, RAL 7037

外型尺寸 (mm)	Metr.	PG	型号	订货号
<p>顶部进线</p>	M20	PG11	H3A-MTG-PG11 H3A-MTG-M20	T 1 32 903 0111-000 T 1 32 903 0120-000
<p>侧面进线</p>	M20	PG11	H3A-MTS-PG11 H3A-MTS-M20	T 1 31 903 0111-000 T 1 31 903 0120-000
<p>开孔安装</p>			H3A-MAG	T 1 50 903 0000-000
<p>开孔安装 (侧出形式)</p>			H3A-MAGS	T 1 54 903 0000-000
<p>表面安装(侧面形式)</p>	M16 M20	PG11	H3A-MAGSV-PG11 H3A-MAGSV-M16 H3A-MAGSV-M20	T 1 61 903 0111-000 T 1 61 903 0116-000 T 1 61 903 0120-000
<p>电缆对接下壳</p>	M20	PG11	H3A-MTGVB-PG11 H3A-MTGVB-M20	T 1 73 903 0111-000 T 1 73 903 0120-000
<p>上壳(保护盖(塑料))</p> <p>备注:适配公插+上壳</p>			H3A-KDTP	T 1 01 003 1100-000
<p>金属底座保护盖</p> <p>备注:适配母插+下壳</p>			H3A-KDB	T 1 01 003 3100-000

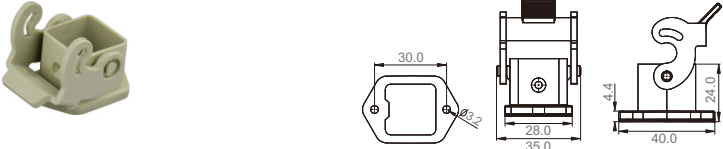
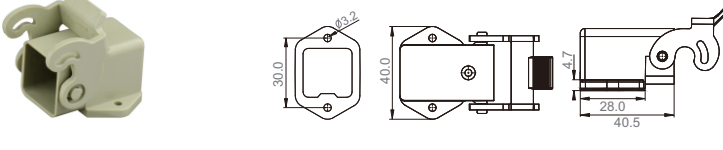
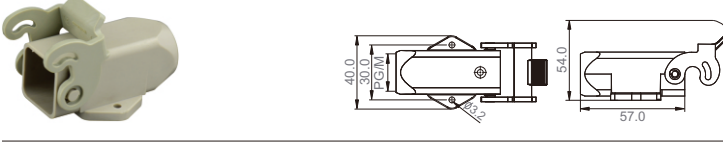
H3A 塑料外壳

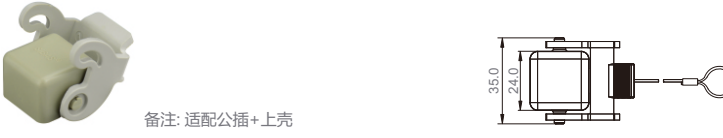
塑料外壳

外型尺寸 (mm)	Metr.	PG	型号	订货号
<p>顶部进线</p> 	M20	PG11	H3A-TG-PG11 H3A-TG-M20	T 1 32 903 1111-000 T 1 32 903 1120-000
<p>侧面进线</p> 	M20	PG11	H3A-TS-PG11 H3A-TS-M20	T 1 31 903 1111-000 T 1 31 903 1120-000
<p>开孔安装</p> 			H3A-AG	T 1 50 903 1100-000
<p>开孔安装 (侧出形式)</p> 			H3A-AGS	T 1 54 903 1111-000
<p>表面安装 (侧面形式)</p> 	M16 M20	PG11	H3A-AGSV-PG11 H3A-AGSV-M16 H3A-AGSV-M20	T 1 61 903 1111-000 T 1 61 903 1116-000 T 1 61 903 1120-000
<p>电缆对接下壳:</p> 	M20	PG11	H3A-TGVB-PG11 H3A-TGVB-M20	T 1 73 903 1111-000 T 1 73 903 1120-000
<p>上壳保护盖 (塑料)</p>  <p>备注: 适配公插+上壳</p>			H3A-KDTP	T 1 01 003 1100-000
<p>底座保护盖</p>  <p>白 灰</p> <p>备注: 适配公插+上壳</p>			H3A-KDBP(White) H3A-KDBP(Grey) H3A-KDBP(White) H3A-KDBP(Grey)	T 1 01 003 3200-000 T 1 01 003 2200-000 T 1 01 003 2100-000 T 1 01 003 2300-000

HD-015 接插体

芯件适配 H10A 外壳

15+ ⊕ (车针)

250V 10A

外型尺寸 (mm)

冷压接 (冷压针需单独订购)



接插针排序

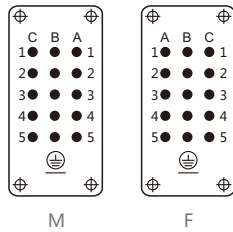

1) 接插体之间最大距离24mm

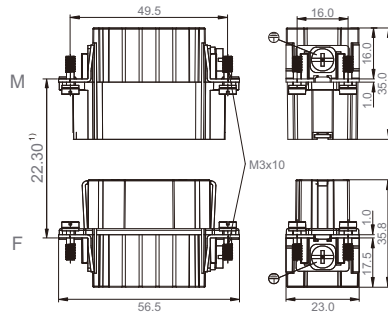

不使用防护外壳时芯体的安装开孔图

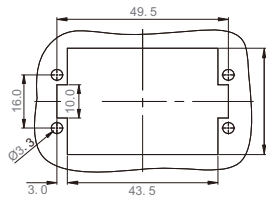

公接插件	订货号		型号
	母接插件		
T 2 02 015 2101-000			HD-015-M
	T 2 02 015 2201-000		HD-015-F

插针

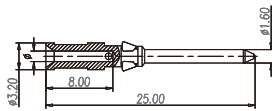

线规	剥线长度	镀银冷压接插针		镀金冷压接插针		
		型号	订货号	型号	订货号	
0.14mm ²	AWG26-22	8.0mm	CDM-0.14	T 2 02 000 1002-000	DDM-0.14	T 2 02 001 1002-000
0.5mm ²	AWG20	8.0mm	CDM-0.5	T 2 02 000 1005-000	DDM-0.5	T 2 02 001 1005-000
0.75mm ²	AWG18	8.0mm	CDM-0.75	T 2 02 000 1008-000	DDM-0.75	T 2 02 001 1008-000
1.0mm ²	AWG18	8.0mm	CDM-1.0	T 2 02 000 1010-000	DDM-1.0	T 2 02 001 1010-000
1.5mm ²	AWG16	8.0mm	CDM-1.5	T 2 02 000 1015-000	DDM-1.5	T 2 02 001 1015-000
2.5mm ²	AWG14	6.0mm	CDM-2.5	T 2 02 000 1025-000	DDM-2.5	T 2 02 001 1025-000

插孔

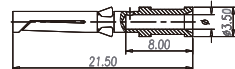

线规	剥线长度	镀银冷压接插针		镀金冷压接插针		
		型号	订货号	型号	订货号	
0.14mm ²	AWG26-22	8.0mm	CDF-0.14	T 2 02 000 2002-000	DDF-0.14	T 2 02 001 2002-000
0.5mm ²	AWG20	8.0mm	CDF-0.5	T 2 02 000 2005-000	DDF-0.5	T 2 02 001 2005-000
0.75mm ²	AWG18	8.0mm	CDF-0.75	T 2 02 000 2008-000	DDF-0.75	T 2 02 001 2008-000
1.0mm ²	AWG18	8.0mm	CDF-1.0	T 2 02 000 2010-000	DDF-1.0	T 2 02 001 2010-000
1.5mm ²	AWG16	8.0mm	CDF-1.5	T 2 02 000 2015-000	DDF-1.5	T 2 02 001 2015-000
2.5mm ²	AWG14	6.0mm	CDF-2.5	T 2 02 000 2025-000	DDF-2.5	T 2 02 001 2025-000

HD-015 接插体

芯件适配 H10A 外壳

15+⊕ (冷压针:卷针)

250V 10A

外型尺寸 (mm)

卷皮式冷压接 (冷压针需单独订购)

1) 接插体之间最大距离24mm

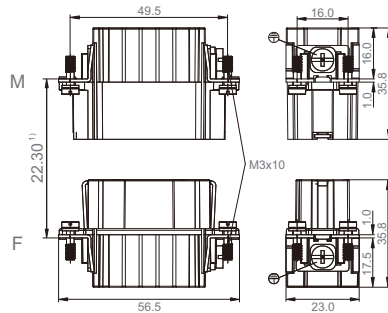

不使用防护外壳时芯体的安装开孔图

接插针排序

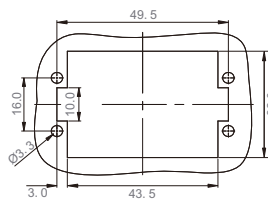
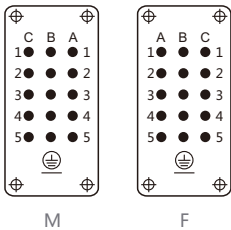

公接插件	订货号		型号
	母接插件		
		T 2 02 015 2101-000	HD-015-M
		T 2 02 015 3201-000	HD-015-FJ

插针

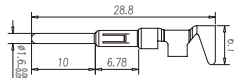

线规	剥线长度	镀银冷压接插针		镀金冷压接插针	
		型号	订货号	型号	订货号
0.14-0.5mm ²	AWG26-20	CJM-14	T 2 20 000 1005-000	DJM-14	T 2 20 001 1005-000
0.5-1.5mm ²	AWG20-16	CJM-50	T 2 20 000 1010-000	DJM-50	T 2 20 001 1010-000
1.5-2.5mm ²	AWG16-14	CJM-150	T 2 20 000 1025-000	DJM-150	T 2 20 001 1025-000



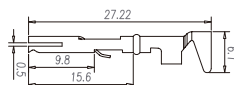





插孔

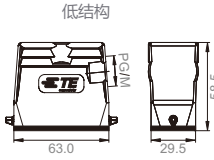

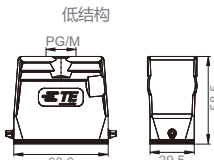
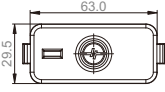
线规	剥线长度	镀银冷压接插针		镀金冷压接插针	
		型号	订货号	型号	订货号
0.14-0.5mm ²	AWG26-20	CJF-14	T 2 20 000 2005-000	DJF-14	T 2 20 001 2005-000
0.5-1.5mm ²	AWG20-16	CJF-50	T 2 20 000 2010-000	DJF-50	T 2 20 001 2010-000
1.5-2.5mm ²	AWG16-14	CJF-150	T 2 20 000 2025-000	DJF-150	T 2 20 001 2025-000

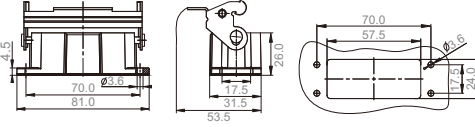
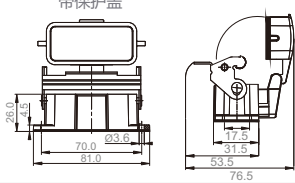
H10A 金属外壳

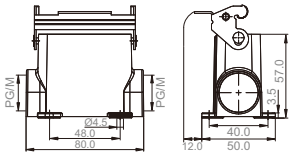
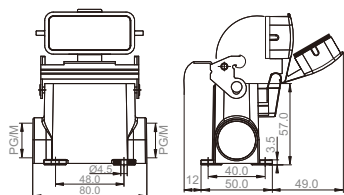
表面粉末镀层, RAL 7037

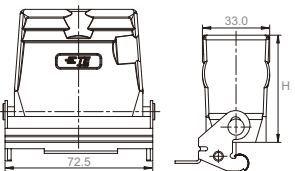
外型尺寸 (mm)	Metr.	PG	型号	订货号						
<p>外壳上壳:侧面进线</p>  <p>低结构</p>  <p>低结构</p>	M20 M25	PG16 PG21	H10A-TS-PG16 H10A-TS-PG21 H10A-TS-M20 H10A-TS-M25	T 1 31 910 0116-000 T 1 31 910 0121-000 T 1 31 910 0120-000 T 1 31 910 0125-000						
<p>外壳上壳:顶部进线</p>  <p>低结构</p>  <p>低结构</p>	M20 M25	PG16 PG21	H10A-TG-PG16 H10A-TG-PG21 H10A-TG-M20 H10A-TG-M25	T 1 32 910 0116-000 T 1 32 910 0121-000 T 1 32 910 0120-000 T 1 32 910 0125-000						
<p>上壳保护盖</p> 			H10A-KDT	T 1 01 910 1101-000 T 1 01 910 1201-000						
<p>外壳底座:开孔安装</p>    <p>带保护盖</p> 			H10A-AGS H10A-ADMS	T 1 50 910 0000-000 T 1 51 910 0000-000						
<p>外壳底座:表面安装</p>    <p>带保护盖</p> 	M20 M25	PG16 PG21	H10A-SGRS-PG16 H10A-SGRS-PG21 H10A-SGRS-M20 H10A-SGRS-M25	T 1 61 910 0116-000 T 1 61 910 0121-000 T 1 61 910 0120-000 T 1 61 910 0125-000						
	M20 M25	PG16 PG21	H10A-SGRS-2PG16 H10A-SGRS-2PG21 H10A-SGRS-2M20 H10A-SGRS-2M25	T 1 61 910 0216-000 T 1 61 910 0221-000 T 1 61 910 0220-000 T 1 61 910 0225-000						
	M20 M25	PG16 PG21	H10A-SDRMS-PG16 H10A-SDRMS-PG21 H10A-SDRMS-M20 H10A-SDRMS-M25	T 1 62 910 0116-000 T 1 62 910 0121-000 T 1 62 910 0120-000 T 1 62 910 0125-000						
	M20 M25	PG16 PG21	H10A-SDRMS-2PG16 H10A-SDRMS-2PG21 H10A-SDRMS-2M20 H10A-SDRMS-2M25	T 1 62 910 0216-000 T 1 62 910 0221-000 T 1 62 910 0220-000 T 1 62 910 0225-000						
<p>电缆对接下壳</p>  <table border="1" data-bbox="354 1984 527 2052"> <tr> <td>结构</td> <td>H</td> </tr> <tr> <td>低结构</td> <td>52.6</td> </tr> <tr> <td>高结构</td> <td>66.6</td> </tr> </table> 	结构	H	低结构	52.6	高结构	66.6	M20 M25	PG16	H10A-TBFS-PG16 H10A-TBFS-M20 H10A-TBFS-M25	T 1 73 910 0116-000 T 1 73 910 0120-000 T 1 73 910 0125-000
结构	H									
低结构	52.6									
高结构	66.6									

HD-025 接插体

芯件适配 H16A 外壳

25+ ⊕ (车针)

250V 10A

外型尺寸 (mm)

冷压接 (冷压针需单独订购)

1) 接插体之间最大距离24mm

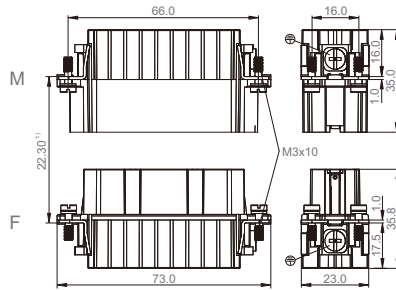
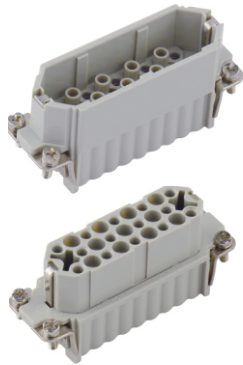

不使用防护外壳时芯体的安装开孔图

接插针排序

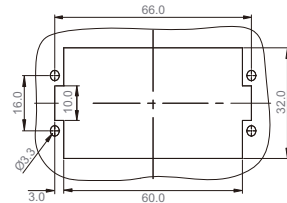
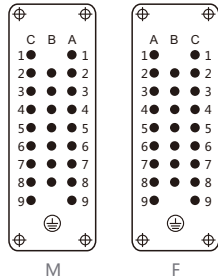

公接插件	订货号		型号
	母接插件		
T 2 02 025 2101-000			HD-025-M
	T 2 02 025 2201-000		HD-025-F

插针

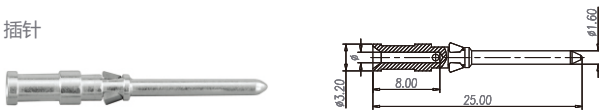

线规	剥线长度	镀银冷压接插针		镀金冷压接插针		
		型号	订货号	型号	订货号	
0.14mm ²	AWG26-22	8.0mm	CDM-0.14	T 2 02 000 1002-000	DDM-0.14	T 2 02 001 1002-000
0.5mm ²	AWG20	8.0mm	CDM-0.5	T 2 02 000 1005-000	DDM-0.5	T 2 02 001 1005-000
0.75mm ²	AWG18	8.0mm	CDM-0.75	T 2 02 000 1008-000	DDM-0.75	T 2 02 001 1008-000
1.0mm ²	AWG18	8.0mm	CDM-1.0	T 2 02 000 1010-000	DDM-1.0	T 2 02 001 1010-000
1.5mm ²	AWG16	8.0mm	CDM-1.5	T 2 02 000 1015-000	DDM-1.5	T 2 02 001 1015-000
2.5mm ²	AWG14	6.0mm	CDM-2.5	T 2 02 000 1025-000	DDM-2.5	T 2 02 001 1025-000

插孔

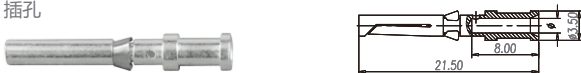

线规	剥线长度	镀银冷压接插针		镀金冷压接插针		
		型号	订货号	型号	订货号	
0.14mm ²	AWG26-22	8.0mm	CDF-0.14	T 2 02 000 2002-000	DDF-0.14	T 2 02 001 2002-000
0.5mm ²	AWG20	8.0mm	CDF-0.5	T 2 02 000 2005-000	DDF-0.5	T 2 02 001 2005-000
0.75mm ²	AWG18	8.0mm	CDF-0.75	T 2 02 000 2008-000	DDF-0.75	T 2 02 001 2008-000
1.0mm ²	AWG18	8.0mm	CDF-1.0	T 2 02 000 2010-000	DDF-1.0	T 2 02 001 2010-000
1.5mm ²	AWG16	8.0mm	CDF-1.5	T 2 02 000 2015-000	DDF-1.5	T 2 02 001 2015-000
2.5mm ²	AWG14	6.0mm	CDF-2.5	T 2 02 000 2025-000	DDF-2.5	T 2 02 001 2025-000

HD-025 接插体

芯件适配 H16A 外壳

25+ ⊕ (冷压针:卷针)

250V 10A

外型尺寸 (mm)

卷皮式冷压接 (冷压针需单独订购)

1) 接插体之间最大距离24mm

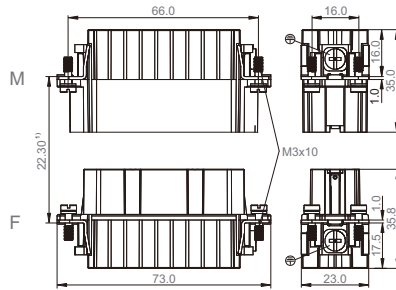

不使用防护外壳时芯体的安装开孔图

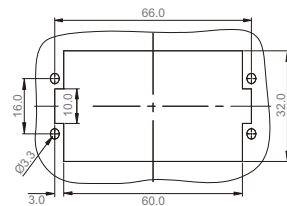
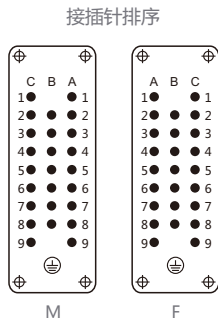

公接插件	订货号		型号
	母接插件		
		T 2 02 025 2101-000	HD-025-M
		T 2 02 025 3201-000	HD-025-FJ

插针

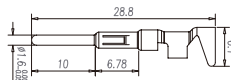

线规	剥线长度	镀银冷压接插针		镀金冷压接插针	
		型号	订货号	型号	订货号
0.14-0.5mm ²	AWG26-20	CJM-14	T 2 20 000 1005-000	DJM-14	T 2 20 001 1005-000
0.5-1.5mm ²	AWG20-16	CJM-50	T 2 20 000 1010-000	DJM-50	T 2 20 001 1010-000
1.5-2.5mm ²	AWG16-14	CJM-150	T 2 20 000 1025-000	DJM-150	T 2 20 001 1025-000



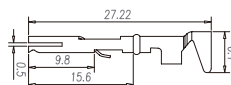









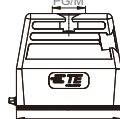

插孔

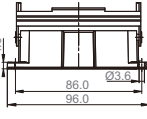
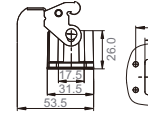

线规	剥线长度	镀银冷压接插针		镀金冷压接插针	
		型号	订货号	型号	订货号
0.14-0.5mm ²	AWG26-20	CJF-14	T 2 20 000 2005-000	DJF-14	T 2 20 001 2005-000
0.5-1.5mm ²	AWG20-16	CJF-50	T 2 20 000 2010-000	DJF-50	T 2 20 001 2010-000
1.5-2.5mm ²	AWG16-14	CJF-150	T 2 20 000 2025-000	DJF-150	T 2 20 001 2025-000

H16A 金属外壳

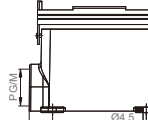
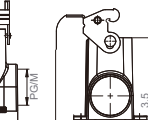
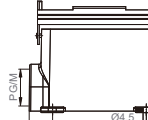
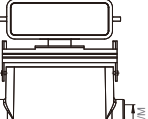
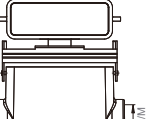
表面粉末镀层, RAL 7037

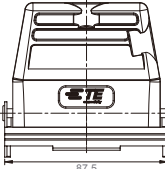
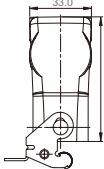
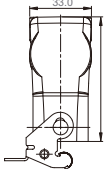
外型尺寸 (mm)	Metr.	PG	型号	订货号						
外壳上壳:侧面进线  <div style="display: flex; justify-content: space-around;"> <div style="text-align: center;"> <p>低结构</p>  <p>79.0 29.5 59.5</p> </div> <div style="text-align: center;"> <p>高结构</p>  <p>79.0 29.5 72.4</p> </div> </div>	低结构 M20 M25	PG16 PG21	H16A-TS-PG16 H16A-TS-PG21 H16A-TS-M20 H16A-TS-M25	T 1 31 916 0116-000 T 1 31 916 0121-000 T 1 31 916 0120-000 T 1 31 916 0125-000						
<div style="text-align: center;"> <p>高结构</p>  <p>79.0 29.5 72.4</p> </div>			高结构 M25	PG21	H16A-TSH-PG21 H16A-TSH-M25	T 1 33 916 0121-000 T 1 33 916 0125-000				
外壳上壳:顶部进线  <div style="display: flex; justify-content: space-around;"> <div style="text-align: center;"> <p>低结构</p>  <p>79.0 29.5 38.5</p> </div> <div style="text-align: center;"> <p>高结构</p>  <p>79.0 29.5 72.4</p> </div> </div>	低结构 M20 M25	PG16 PG21	H16A-TG-PG16 H16A-TG-PG21 H16A-TG-M20 H16A-TG-M25	T 1 32 916 0116-000 T 1 32 916 0121-000 T 1 32 916 0120-000 T 1 32 916 0125-000						
<div style="text-align: center;"> <p>高结构</p>  <p>79.0 29.5 72.4</p> </div>			高结构 M25	PG21	H16A-TGH-PG21 H16A-TGH-M25	T 1 34 916 0121-000 T 1 34 916 0125-000				
上壳保护盖  <p style="text-align: center;">79.0 29.5</p>			H16A-KDT	T 1 01 916 1101-000 T 1 01 916 1201-000						
外壳底座:开孔安装   <div style="display: flex; justify-content: space-around;"> <div style="text-align: center;"> <p>带保护盖</p>  <p>86.0 96.0 41.5 23.6</p> </div> <div style="text-align: center;"> <p>带保护盖</p>  <p>86.0 96.0 41.5 24.0</p> </div> </div>			H16A-AGS	T 1 50 916 1000-000						
外壳底座:表面安装   <div style="display: flex; justify-content: space-around;"> <div style="text-align: center;"> <p>带保护盖</p>  <p>64.0 96.0 44.5 24.5</p> </div> <div style="text-align: center;"> <p>带保护盖</p>  <p>64.0 96.0 44.5 24.0</p> </div> </div>	1-进线孔 M20 M25	PG16 PG21	H16A-SGRS-PG16 H16A-SGRS-PG21 H16A-SGRS-M20 H16A-SGRS-M25	T 1 61 916 1116-000 T 1 61 916 1121-000 T 1 61 916 1120-000 T 1 61 916 1125-000						
<div style="text-align: center;"> <p>带保护盖</p>  <p>64.0 96.0 44.5 24.5</p> </div>			2-进线孔 M20 M25	PG16 PG21	H16A-SGRS-2PG16 H16A-SGRS-2PG21 H16A-SGRS-2M20 H16A-SGRS-2M25	T 1 61 916 1216-000 T 1 61 916 1221-000 T 1 61 916 1220-000 T 1 61 916 1225-000				
<div style="text-align: center;"> <p>带保护盖</p>  <p>64.0 96.0 44.5 24.5</p> </div>	1-进线孔 M20 M25	PG16 PG21			H16A-SDRMS-PG16 H16A-SDRMS-PG21 H16A-SDRMS-M20 H16A-SDRMS-M25	T 1 62 916 1116-000 T 1 62 916 1121-000 T 1 62 916 1120-000 T 1 62 916 1125-000				
<div style="text-align: center;"> <p>带保护盖</p>  <p>64.0 96.0 44.5 24.5</p> </div>			2-进线孔 M20 M25	PG16 PG21	H16A-SDRMS-2PG16 H16A-SDRMS-2PG21 H16A-SDRMS-2M20 H16A-SDRMS-2M25	T 1 62 916 1216-000 T 1 62 916 1221-000 T 1 62 916 1220-000 T 1 62 916 1225-000				
电缆对接下壳  <table border="1" style="margin-left: 20px;"> <tr> <th>结构</th> <th>H</th> </tr> <tr> <td>低结构</td> <td>66.6</td> </tr> <tr> <td>高结构</td> <td>80.6</td> </tr> </table> <div style="display: flex; justify-content: space-around;"> <div style="text-align: center;">  <p>87.5</p> </div> <div style="text-align: center;">  <p>33.0 H</p> </div> </div>	结构	H			低结构	66.6	高结构	80.6	低结构 M20 M25	PG16
结构	H									
低结构	66.6									
高结构	80.6									
<div style="text-align: center;"> <p>高结构</p>  <p>33.0 H</p> </div>	高结构 M25	PG21	H16A-TBFHS-PG21 H16A-TBFHS-M25	T 1 77 916 1121-000 T 1 77 916 1125-000						

HD-050 接插体

芯件适配 H32A 外壳

50+ \oplus (车针)
(25x2)

250V 10A

外型尺寸 (mm)

冷压接 (冷压针需单独订购)

接插针排序

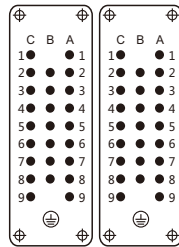

M

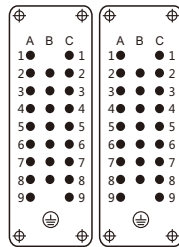

F

订货号		型号
公接插件	母接插件	
T 2 02 025 2101-000		HD-025-M(1-25)
T 2 02 050 2101-000		HD-025-M(26-50)
	T 2 02 025 2201-000	HD-025-F(1-25)
	T 2 02 050 2201-000	HD-025-F(26-50)

插针

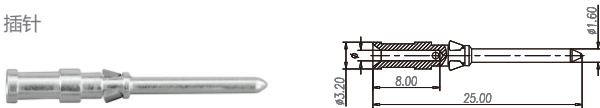

1) 接插体之间最大距离24mm

冷压接

线规	剥线长度	镀银冷压接插针		镀金冷压接插针		
		型号	订货号	型号	订货号	
0.14mm ²	AWG26-22	8.0mm	CDM-0.14	T 2 02 000 1002-000	DDM-0.14	T 2 02 001 1002-000
0.5mm ²	AWG20	8.0mm	CDM-0.5	T 2 02 000 1005-000	DDM-0.5	T 2 02 001 1005-000
0.75mm ²	AWG18	8.0mm	CDM-0.75	T 2 02 000 1008-000	DDM-0.75	T 2 02 001 1008-000
1.0mm ²	AWG18	8.0mm	CDM-1.0	T 2 02 000 1010-000	DDM-1.0	T 2 02 001 1010-000
1.5mm ²	AWG16	8.0mm	CDM-1.5	T 2 02 000 1015-000	DDM-1.5	T 2 02 001 1015-000
2.5mm ²	AWG14	6.0mm	CDM-2.5	T 2 02 000 1025-000	DDM-2.5	T 2 02 001 1025-000

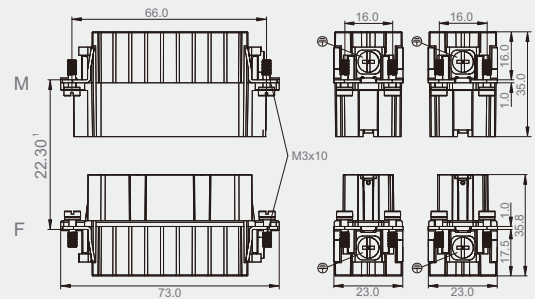

插孔



不使用防护外壳时芯体的安装开孔图

线规	剥线长度	镀银冷压接插针		镀金冷压接插针		
		型号	订货号	型号	订货号	
0.14mm ²	AWG26-22	8.0mm	CDF-0.14	T 2 02 000 2002-000	DDF-0.14	T 2 02 001 2002-000
0.5mm ²	AWG20	8.0mm	CDF-0.5	T 2 02 000 2005-000	DDF-0.5	T 2 02 001 2005-000
0.75mm ²	AWG18	8.0mm	CDF-0.75	T 2 02 000 2008-000	DDF-0.75	T 2 02 001 2008-000
1.0mm ²	AWG18	8.0mm	CDF-1.0	T 2 02 000 2010-000	DDF-1.0	T 2 02 001 2010-000
1.5mm ²	AWG16	8.0mm	CDF-1.5	T 2 02 000 2015-000	DDF-1.5	T 2 02 001 2015-000
2.5mm ²	AWG14	6.0mm	CDF-2.5	T 2 02 000 2025-000	DDF-2.5	T 2 02 001 2025-000

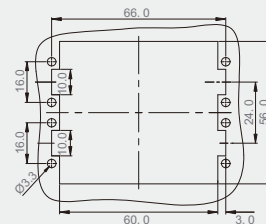

H32A 金属外壳

表面粉末镀层, RAL 7037

外型尺寸 (mm)

外壳上壳侧面进线

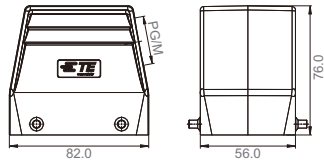
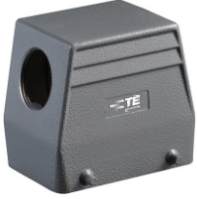

外壳上壳:顶部进线

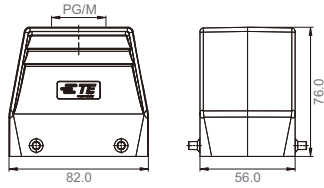
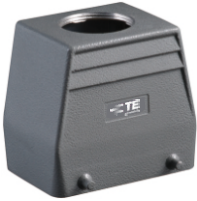

外壳底座:开孔安装

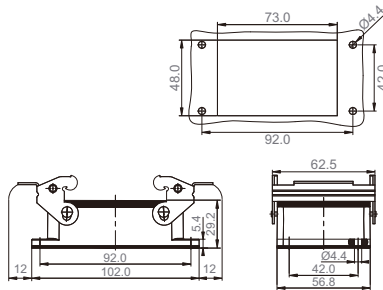

外壳底座:表面安装

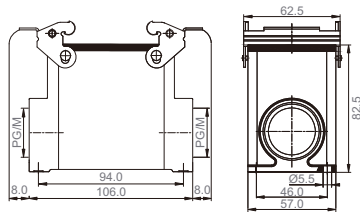

Metr.

PG

型号

订货号

M25 M32 M40	PG21	H32A-TS-PG21	T 1 31 932 0121-000
	PG29	H32A-TS-PG29	T 1 31 932 0129-000
	PG36	H32A-TS-PG36	T 1 31 932 0136-000
		H32A-TS-M25	T 1 31 932 0125-000
		H32A-TS-M32	T 1 31 932 0132-000
		H32A-TS-M40	T 1 31 932 0140-000

M25 M32 M40	PG21	H32A-TG-PG21	T 1 32 932 0121-000
	PG29	H32A-TG-PG29	T 1 32 932 0129-000
	PG36	H32A-TG-PG36	T 1 32 932 0136-000
		H32A-TG-M25	T 1 32 932 0125-000
		H32A-TG-M32	T 1 32 932 0132-000
		H32A-TG-M40	T 1 32 932 0140-000

H32A-AG	T 1 41 932 0000-000
---------	---------------------

1-进线孔
2-进线孔

M25 M32	PG21	H32A-SGR-PG21	T 1 44 932 0121-000
	PG29	H32A-SGR-PG29	T 1 44 932 0129-000
		H32A-SGR-M25	T 1 44 932 0125-000
M25 M32		H32A-SGR-M32	T 1 44 932 0132-000
	PG21	H32A-SGR-2PG21	T 1 44 932 0221-000
	PG29	H32A-SGR-2PG29	T 1 44 932 0229-000
		H32A-SGR-2M25	T 1 44 932 0225-000
		H32A-SGR-2M32	T 1 44 932 0232-000

HDD-016 接插体

芯件适配 H6B 外壳

16+⊕ (车针)

250V 10A

外型尺寸 (mm)

冷压接 (冷压针需单独订购)

1) 接插体之间最大距离24mm

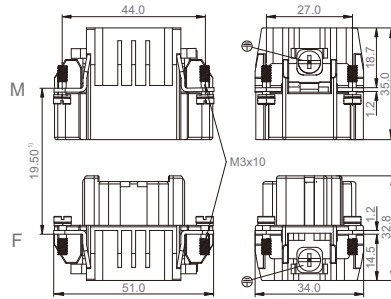

不使用防护外壳时芯体的安装开孔图

接插针排序

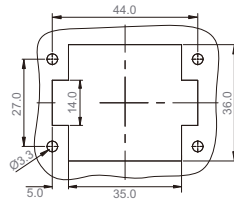
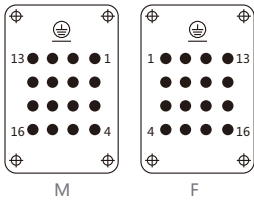

公接插件	订货号		型号
	母接插件		
		T 2 03 016 2101-000	HDD-016-M
		T 2 03 016 2201-000	HDD-016-F

插针

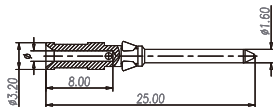

线规	剥线长度	镀银冷压接插针		镀金冷压接插针	
		型号	订货号	型号	订货号
0.14mm ²	AWG26-22	CDM-0.14	T 2 02 000 1002-000	DDM-0.14	T 2 02 001 1002-000
0.5mm ²	AWG20	CDM-0.5	T 2 02 000 1005-000	DDM-0.5	T 2 02 001 1005-000
0.75mm ²	AWG18	CDM-0.75	T 2 02 000 1008-000	DDM-0.75	T 2 02 001 1008-000
1.0mm ²	AWG18	CDM-1.0	T 2 02 000 1010-000	DDM-1.0	T 2 02 001 1010-000
1.5mm ²	AWG16	CDM-1.5	T 2 02 000 1015-000	DDM-1.5	T 2 02 001 1015-000
2.5mm ²	AWG14	CDM-2.5	T 2 02 000 1025-000	DDM-2.5	T 2 02 001 1025-000

插孔

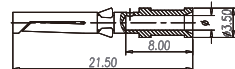

线规	剥线长度	镀银冷压接插针		镀金冷压接插针	
		型号	订货号	型号	订货号
0.14mm ²	AWG26-22	CDF-0.14	T 2 02 000 2002-000	DDF-0.14	T 2 02 001 2002-000
0.5mm ²	AWG20	CDF-0.5	T 2 02 000 2005-000	DDF-0.5	T 2 02 001 2005-000
0.75mm ²	AWG18	CDF-0.75	T 2 02 000 2008-000	DDF-0.75	T 2 02 001 2008-000
1.0mm ²	AWG18	CDF-1.0	T 2 02 000 2010-000	DDF-1.0	T 2 02 001 2010-000
1.5mm ²	AWG16	CDF-1.5	T 2 02 000 2015-000	DDF-1.5	T 2 02 001 2015-000
2.5mm ²	AWG14	CDF-2.5	T 2 02 000 2025-000	DDF-2.5	T 2 02 001 2025-000

HDD-024 接插体

芯件适配 H6B 外壳

24+⊕ (车针)

250V 10A

外型尺寸 (mm)

冷压接 (冷压针需单独订购)

1) 接插体之间最大距离24mm

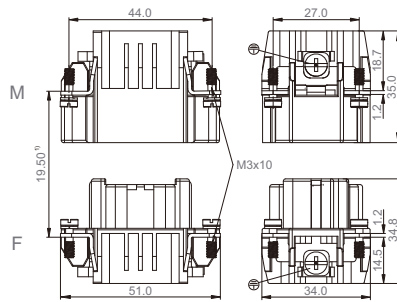
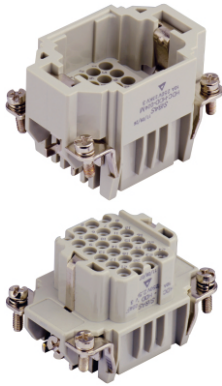

不使用防护外壳时芯体的安装开孔图

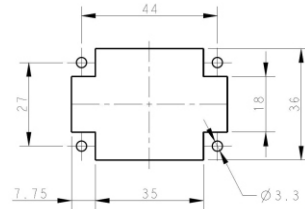

接插针排序

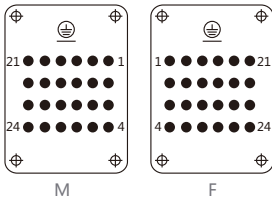

公接插件	订货号		型号
	母接插件		
T 2 03 024 2101-000			HDD-024-M
	T 2 03 024 2201-000		HDD-024-F

插针

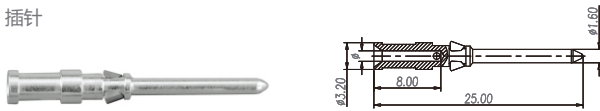

线规	剥线长度	镀银冷压接插针		镀金冷压接插针		
		型号	订货号	型号	订货号	
0.14mm ²	AWG26-22	8.0mm	CDM-0.14	T 2 02 000 1002-000	DDM-0.14	T 2 02 001 1002-000
0.5mm ²	AWG20	8.0mm	CDM-0.5	T 2 02 000 1005-000	DDM-0.5	T 2 02 001 1005-000
0.75mm ²	AWG18	8.0mm	CDM-0.75	T 2 02 000 1008-000	DDM-0.75	T 2 02 001 1008-000
1.0mm ²	AWG18	8.0mm	CDM-1.0	T 2 02 000 1010-000	DDM-1.0	T 2 02 001 1010-000
1.5mm ²	AWG16	8.0mm	CDM-1.5	T 2 02 000 1015-000	DDM-1.5	T 2 02 001 1015-000
2.5mm ²	AWG14	6.0mm	CDM-2.5	T 2 02 000 1025-000	DDM-2.5	T 2 02 001 1025-000

插孔



线规	剥线长度	镀银冷压接插针		镀金冷压接插针		
		型号	订货号	型号	订货号	
0.14mm ²	AWG26-22	8.0mm	CDF-0.14	T 2 02 000 2002-000	DDF-0.14	T 2 02 001 2002-000
0.5mm ²	AWG20	8.0mm	CDF-0.5	T 2 02 000 2005-000	DDF-0.5	T 2 02 001 2005-000
0.75mm ²	AWG18	8.0mm	CDF-0.75	T 2 02 000 2008-000	DDF-0.75	T 2 02 001 2008-000
1.0mm ²	AWG18	8.0mm	CDF-1.0	T 2 02 000 2010-000	DDF-1.0	T 2 02 001 2010-000
1.5mm ²	AWG16	8.0mm	CDF-1.5	T 2 02 000 2015-000	DDF-1.5	T 2 02 001 2015-000
2.5mm ²	AWG14	6.0mm	CDF-2.5	T 2 02 000 2025-000	DDF-2.5	T 2 02 001 2025-000

HDD-024 接插体

芯件适配 H6B 外壳

24+⊕ (冷压针:卷针)

250V 10A

外型尺寸 (mm)

卷皮式冷压接 (冷压针需单独订购)

1) 接插体之间最大距离24mm

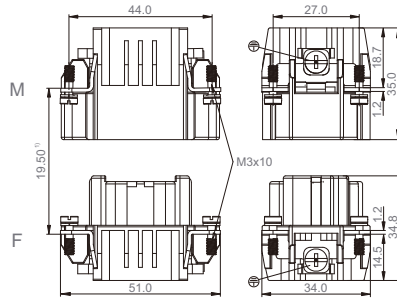
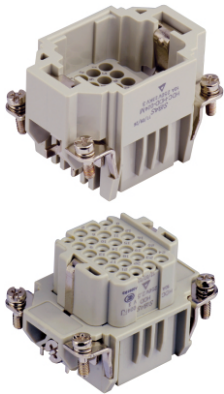

不使用防护外壳时芯体的安装开孔图

接插针排序

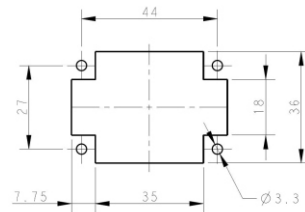
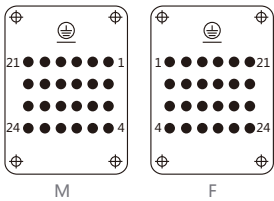

公接插件	订货号		型号
	母接插件		
T 2 03 024 2101-000			HDD-024-M
	T 2 03 024 3201-000		HDD-024-FJ

插针

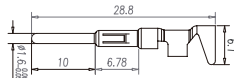

线规	剥线长度	镀银冷压接插针		镀金冷压接插针	
		型号	订货号	型号	订货号
0.14-0.5mm ²	AWG26-20	CJM-14	T 2 20 000 1005-000	DJM-14	T 2 20 001 1005-000
0.5-1.5mm ²	AWG20-16	CJM-50	T 2 20 000 1010-000	DJM-50	T 2 20 001 1010-000
1.5-2.5mm ²	AWG16-14	CJM-150	T 2 20 000 1025-000	DJM-150	T 2 20 001 1025-000

插孔

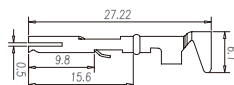

线规	剥线长度	镀银冷压接插针		镀金冷压接插针	
		型号	订货号	型号	订货号
0.14-0.5mm ²	AWG26-20	CJF-14	T 2 20 000 2005-000	DJF-14	T 2 20 001 2005-000
0.5-1.5mm ²	AWG20-16	CJF-50	T 2 20 000 2010-000	DJF-50	T 2 20 001 2010-000
1.5-2.5mm ²	AWG16-14	CJF-150	T 2 20 000 2025-000	DJF-150	T 2 20 001 2025-000

H6B 带单扣外壳

表面粉末镀层, RAL 7037

外型尺寸 (mm)

外壳上壳侧面进线



低结构

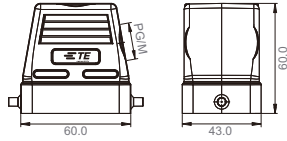

高结构

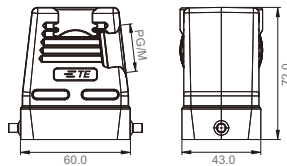

外壳上壳:顶部进线



低结构

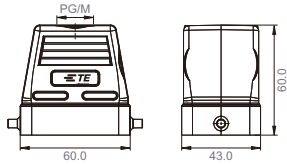

高结构

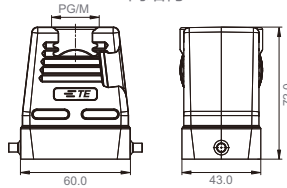

电缆对接下壳

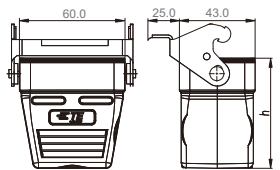

结构	h
低结构	62.5
高结构	74.5

低结构
高结构

上壳保护壳

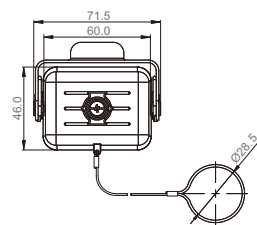

Metr.	PG	型号	订货号	
M20 M25	PG16	H6B-TS-PG16	T 1 31 006 0116-000	
	PG21	H6B-TS-PG21	T 1 31 006 0121-000	
		H6B-TS-M20	T 1 31 006 0120-000	
		H6B-TS-M25	T 1 31 006 0125-000	
M20 M25 M32	PG21	H6B-TSH-PG21	T 1 33 006 0121-000	
	PG29	H6B-TSH-PG29	T 1 33 006 0129-000	
		H6B-TSH-M20	T 1 33 006 0120-000	
		H6B-TSH-M25	T 1 33 006 0125-000	
		H6B-TSH-M32	T 1 33 006 0132-000	
M20 M25	PG16	H6B-TG-PG16	T 1 32 006 0116-000	
	PG21	H6B-TG-PG21	T 1 32 006 0121-000	
		H6B-TG-M20	T 1 32 006 0120-000	
		H6B-TG-M25	T 1 32 006 0125-000	
M20 M25 M32	PG21	H6B-TGH-PG21	T 1 34 006 0121-000	
	PG29	H6B-TGH-PG29	T 1 34 006 0129-000	
		H6B-TGH-M20	T 1 34 006 0120-000	
		H6B-TGH-M25	T 1 34 006 0125-000	
		H6B-TGH-M32	T 1 34 006 0132-000	
M20 M25 M32	PG16	H6B-TBF-PG16	T 1 73 006 3116-000	
	M20 M25	H6B-TBF-M20	T 1 73 006 3120-000	
		H6B-TBF-M25	T 1 73 006 3125-000	
		PG21	H6B-TBFH-PG21	T 1 77 006 3121-000
	M20 M25 M32	PG29	H6B-TBFH-PG29	T 1 77 006 3129-000
			H6B-TBFH-M20	T 1 77 006 3120-000
		H6B-TBFH-M25	T 1 77 006 3125-000	
		H6B-TBFH-M32	T 1 77 006 3132-000	
		H6B-KDTP	T 1 01 006 1400-000	

H6B 带单扣外壳

表面粉末镀层, RAL 7037

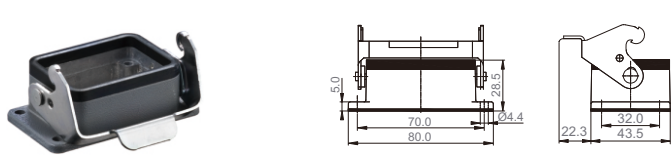
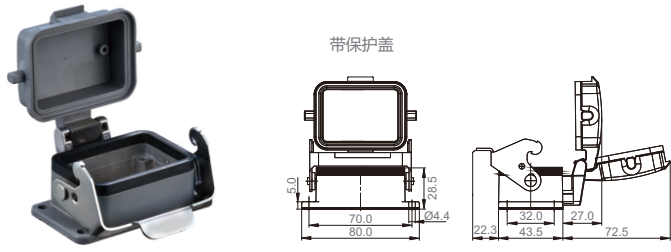
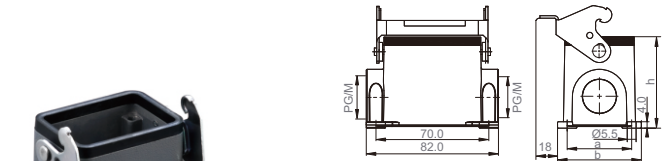
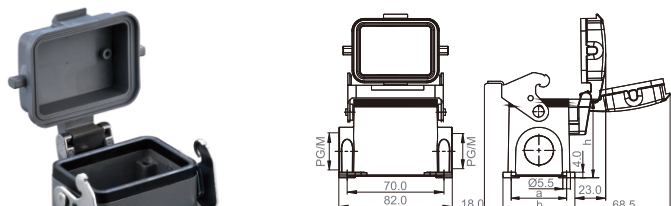
外型尺寸(mm)	Metr.	PG	型号	订货号													
<p>外壳底座开孔安装</p> 			H6B-AG H6B-AGS	T 1 50 006 3000-000 T 1 34 006 0121-100													
<p>带保护盖</p> 			H6B-AD H6B-ADS	T 1 51 006 3000-000 T 1 51 006 2100-000													
<p>外壳底座:表面安装</p>  <table border="1" data-bbox="568 1224 795 1315"> <thead> <tr> <th>结构</th> <th>a</th> <th>b</th> <th>h</th> </tr> </thead> <tbody> <tr> <td>低结构</td> <td>40</td> <td>52</td> <td>61</td> </tr> <tr> <td>高结构</td> <td>45</td> <td>57</td> <td>76</td> </tr> </tbody> </table>	结构	a	b	h	低结构	40	52	61	高结构	45	57	76	<p>低结构</p> <p>1 进线孔</p> <p>2 进线孔</p> <p>高结构</p> <p>1 进线孔</p> <p>2 进线孔</p>	<p>M20</p> <p>M25</p> <p>M20</p> <p>M25</p> <p>M25</p> <p>M32</p> <p>M25</p> <p>M32</p> <p>M25</p> <p>M32</p>	<p>PG16</p> <p>PG21</p> <p>PG16</p> <p>PG21</p> <p>PG21</p> <p>PG29</p> <p>PG21</p> <p>PG29</p> <p>PG16</p> <p>PG21</p> <p>PG21</p> <p>PG29</p> <p>PG21</p> <p>PG29</p>	<p>H6B-SGR-PG16</p> <p>H6B-SGR-PG21</p> <p>H6B-SGR-M20</p> <p>H6B-SGR-M25</p> <p>H6B-SGR-2PG16</p> <p>H6B-SGR-2PG21</p> <p>H6B-SGR-2M20</p> <p>H6B-SGR-2M25</p> <p>H6B-SGRH-PG21</p> <p>H6B-SGRH-PG29</p> <p>H6B-SGRH-M25</p> <p>H6B-SGRH-M32</p> <p>H6B-SGRH-2PG21</p> <p>H6B-SGRH-2PG29</p> <p>H6B-SGRH-2M25</p> <p>H6B-SGRH-2M32</p> <p>H6B-SDR-PG16</p> <p>H6B-SDR-PG21</p> <p>H6B-SDR-M20</p> <p>H6B-SDR-M25</p> <p>H6B-SDR-2PG16</p> <p>H6B-SDR-2PG21</p> <p>H6B-SDR-2M20</p> <p>H6B-SDR-2M25</p> <p>H6B-SDRH-PG21</p> <p>H6B-SDRH-PG29</p> <p>H6B-SDRH-M25</p> <p>H6B-SDRH-M32</p> <p>H6B-SDRH-2PG21</p> <p>H6B-SDRH-2PG29</p> <p>H6B-SDRH-2M25</p> <p>H6B-SDRH-2M32</p>	<p>T 1 61 006 3116-000</p> <p>T 1 61 006 3121-000</p> <p>T 1 61 006 3120-000</p> <p>T 1 61 006 3125-000</p> <p>T 1 61 006 3216-000</p> <p>T 1 61 006 3221-000</p> <p>T 1 61 006 3220-000</p> <p>T 1 61 006 3225-000</p> <p>T 1 65 006 3121-000</p> <p>T 1 65 006 3129-000</p> <p>T 1 65 006 3125-000</p> <p>T 1 65 006 3132-000</p> <p>T 1 65 006 3221-000</p> <p>T 1 65 006 3229-000</p> <p>T 1 65 006 3225-000</p> <p>T 1 65 006 3232-000</p> <p>T 1 62 006 3116-000</p> <p>T 1 62 006 3121-000</p> <p>T 1 62 006 3120-000</p> <p>T 1 62 006 3125-000</p> <p>T 1 62 006 3216-000</p> <p>T 1 62 006 3221-000</p> <p>T 1 62 006 3220-000</p> <p>T 1 62 006 3225-000</p> <p>T 1 66 006 3121-000</p> <p>T 1 66 006 3129-000</p> <p>T 1 66 006 3125-000</p> <p>T 1 66 006 3132-000</p> <p>T 1 66 006 3221-000</p> <p>T 1 66 006 3229-000</p> <p>T 1 66 006 3225-000</p> <p>T 1 66 006 3232-000</p>
结构	a	b	h														
低结构	40	52	61														
高结构	45	57	76														
<p>带保护盖</p>  <table border="1" data-bbox="568 1655 795 1746"> <thead> <tr> <th>结构</th> <th>a</th> <th>b</th> <th>h</th> </tr> </thead> <tbody> <tr> <td>低结构</td> <td>40</td> <td>52</td> <td>61</td> </tr> <tr> <td>高结构</td> <td>45</td> <td>57</td> <td>76</td> </tr> </tbody> </table>	结构	a	b	h	低结构	40	52	61	高结构	45	57	76	<p>低结构</p> <p>1 进线孔</p> <p>2 进线孔</p> <p>高结构</p> <p>1 进线孔</p> <p>2 进线孔</p>	<p>M20</p> <p>M25</p> <p>M20</p> <p>M25</p> <p>M25</p> <p>M32</p> <p>M25</p> <p>M32</p>	<p>PG16</p> <p>PG21</p> <p>PG16</p> <p>PG21</p> <p>PG21</p> <p>PG29</p> <p>PG21</p> <p>PG29</p>	<p>H6B-SDR-PG16</p> <p>H6B-SDR-PG21</p> <p>H6B-SDR-M20</p> <p>H6B-SDR-M25</p> <p>H6B-SDR-2PG16</p> <p>H6B-SDR-2PG21</p> <p>H6B-SDR-2M20</p> <p>H6B-SDR-2M25</p> <p>H6B-SDRH-PG21</p> <p>H6B-SDRH-PG29</p> <p>H6B-SDRH-M25</p> <p>H6B-SDRH-M32</p> <p>H6B-SDRH-2PG21</p> <p>H6B-SDRH-2PG29</p> <p>H6B-SDRH-2M25</p> <p>H6B-SDRH-2M32</p>	<p>T 1 62 006 3116-000</p> <p>T 1 62 006 3121-000</p> <p>T 1 62 006 3120-000</p> <p>T 1 62 006 3125-000</p> <p>T 1 62 006 3216-000</p> <p>T 1 62 006 3221-000</p> <p>T 1 62 006 3220-000</p> <p>T 1 62 006 3225-000</p> <p>T 1 66 006 3121-000</p> <p>T 1 66 006 3129-000</p> <p>T 1 66 006 3125-000</p> <p>T 1 66 006 3132-000</p> <p>T 1 66 006 3221-000</p> <p>T 1 66 006 3229-000</p> <p>T 1 66 006 3225-000</p> <p>T 1 66 006 3232-000</p>
结构	a	b	h														
低结构	40	52	61														
高结构	45	57	76														

HDD-042 接插体

芯件适配 H10B 外壳

42+⊕ (车针)

250V 10A

外型尺寸 (mm)

冷压接 (冷压针需单独订购)

1) 接插体之间最大距离24mm

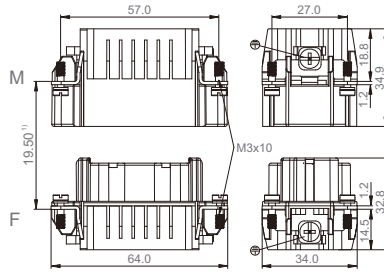

接插针排序

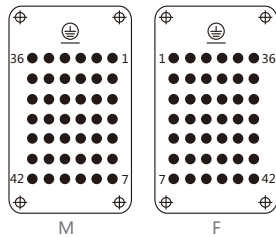

不使用防护外壳时芯体的安装开孔图

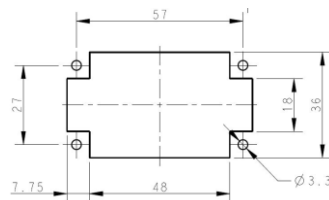

公接插件	订货号		型号
	母接插件		
		T 2 03 042 2101-000	HDD-042-M
		T 2 03 042 2201-000	HDD-042-F

插针

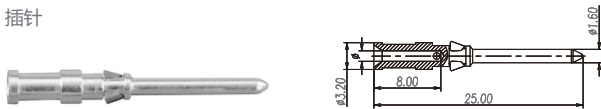

线规	剥线长度	镀银冷压接插针		镀金冷压接插针		
		型号	订货号	型号	订货号	
0.14mm ²	AWG26-22	8.0mm	CDM-0.14	T 2 02 000 1002-000	DDM-0.14	T 2 02 001 1002-000
0.5mm ²	AWG20	8.0mm	CDM-0.5	T 2 02 000 1005-000	DDM-0.5	T 2 02 001 1005-000
0.75mm ²	AWG18	8.0mm	CDM-0.75	T 2 02 000 1008-000	DDM-0.75	T 2 02 001 1008-000
1.0mm ²	AWG18	8.0mm	CDM-1.0	T 2 02 000 1010-000	DDM-1.0	T 2 02 001 1010-000
1.5mm ²	AWG16	8.0mm	CDM-1.5	T 2 02 000 1015-000	DDM-1.5	T 2 02 001 1015-000
2.5mm ²	AWG14	6.0mm	CDM-2.5	T 2 02 000 1025-000	DDM-2.5	T 2 02 001 1025-000

插孔

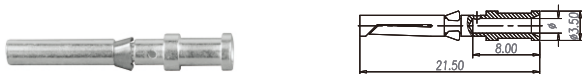

线规	剥线长度	镀银冷压接插针		镀金冷压接插针		
		型号	订货号	型号	订货号	
0.14mm ²	AWG26-22	8.0mm	CDF-0.14	T 2 02 000 2002-000	DDF-0.14	T 2 02 001 2002-000
0.5mm ²	AWG20	8.0mm	CDF-0.5	T 2 02 000 2005-000	DDF-0.5	T 2 02 001 2005-000
0.75mm ²	AWG18	8.0mm	CDF-0.75	T 2 02 000 2008-000	DDF-0.75	T 2 02 001 2008-000
1.0mm ²	AWG18	8.0mm	CDF-1.0	T 2 02 000 2010-000	DDF-1.0	T 2 02 001 2010-000
1.5mm ²	AWG16	8.0mm	CDF-1.5	T 2 02 000 2015-000	DDF-1.5	T 2 02 001 2015-000
2.5mm ²	AWG14	6.0mm	CDF-2.5	T 2 02 000 2025-000	DDF-2.5	T 2 02 001 2025-000

HDD-042 接插体

芯件适配 H10B 外壳

42+⊕ (冷压针:卷针)

250V 10A

外型尺寸 (mm)

卷皮式冷压接 (冷压针需单独订购)

1) 接插体之间最大距离24mm

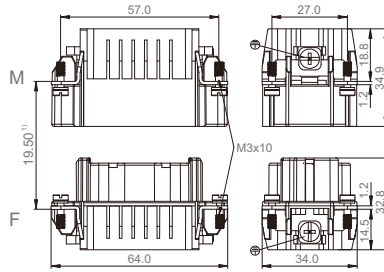

不使用防护外壳时芯体的安装开孔图

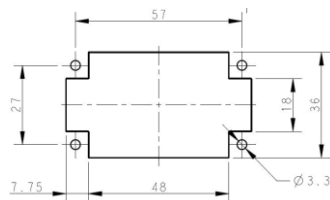

接插针排序

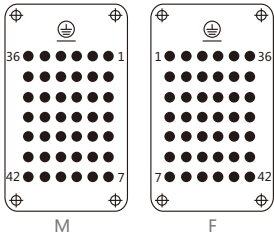

订货号

公接插件

母接插件

型号

T 2 03 042 2101-000

HDD-042-M

T 2 03 042 3201-000

HDD-042-FJ

插针

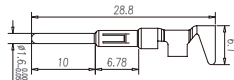

线规	剥线长度	镀银冷压接插针		镀金冷压接插针	
		型号	订货号	型号	订货号
0.14-0.5mm ²	4.0mm	CJM-14	T 2 20 000 1005-000	DJM-14	T 2 20 001 1005-000
0.5-1.5mm ²	4.0mm	CJM-50	T 2 20 000 1010-000	DJM-50	T 2 20 001 1010-000
1.5-2.5mm ²	4.0mm	CJM-150	T 2 20 000 1025-000	DJM-150	T 2 20 001 1025-000



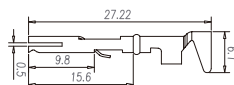







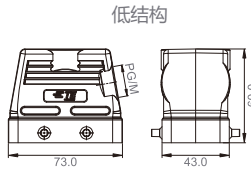

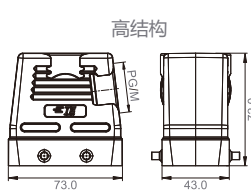
插孔

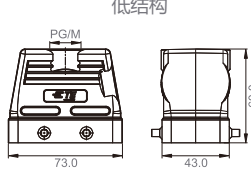

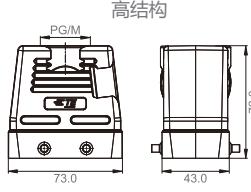
线规	剥线长度	镀银冷压接插针		镀金冷压接插针	
		型号	订货号	型号	订货号
0.14-0.5mm ²	4.0mm	CJF-14	T 2 20 000 2005-000	DJF-14	T 2 20 001 2005-000
0.5-1.5mm ²	4.0mm	CJF-50	T 2 20 000 2010-000	DJF-50	T 2 20 001 2010-000
1.5-2.5mm ²	4.0mm	CJF-150	T 2 20 000 2025-000	DJF-150	T 2 20 001 2025-000

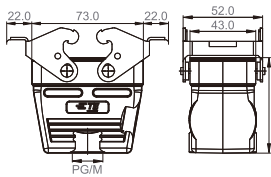
H10B 带双扣外壳

表面粉末镀层, RAL 7037

外型尺寸 (mm)	Metr.	PG	型号	订货号
外壳上壳侧面进线 	M20 M25	PG16 PG21	H10B-TS-PG16 H10B-TS-PG21	T 1 21 010 0116-000 T 1 21 010 0121-000
 <p>低结构</p>			H10B-TS-M20 H10B-TS-M25	T 1 21 010 0120-000 T 1 21 010 0125-000
	M20 M25 M32	PG21 PG29	H10B-TSH-PG21 H10B-TSH-PG29	T 1 23 010 0121-000 T 1 23 010 0129-000
 <p>高结构</p>			H10B-TSH-M20 H10B-TSH-M25 H10B-TSH-M32	T 1 23 010 0120-000 T 1 23 010 0125-000 T 1 23 010 0132-000
外壳上壳:顶部进线 	M20 M25	PG16 PG21	H10B-TG-PG16 H10B-TG-PG21	T 1 22 010 0116-000 T 1 22 010 0121-000
 <p>低结构</p>			H10B-TG-M20 H10B-TG-M25	T 1 22 010 0120-000 T 1 22 010 0125-000
	M20 M25 M32	PG21 PG29	H10B-TGH-PG21 H10B-TGH-PG29	T 1 24 010 0121-000 T 1 24 010 0129-000
 <p>高结构</p>			H10B-TGH-M20 H10B-TGH-M25 H10B-TGH-M32	T 1 24 010 0120-000 T 1 24 010 0125-000 T 1 24 010 0132-000
电缆对接下壳 	M20 M25	PG16	H10B-TBF-PG16 H10B-TBF-M20 H10B-TBF-M25	T 1 71 010 2116-000 T 1 71 010 2120-000 T 1 71 010 2125-000
 <p>低结构</p>			PG21 PG29	H10B-TBFH-PG21 H10B-TBFH-PG29
 <p>高结构</p>	M20 M25	H10B-TBFH-M25 H10B-TBFH-M32		T 1 75 010 2125-000 T 1 75 010 2132-000
上壳保护壳 			H10B-KDTP	T 1 01 010 1200-000
底座保护壳 			H10B-KDBP	T 1 01 010 2100-000

H10B 带双扣外壳

表面粉末镀层, RAL 7037

外型尺寸 (mm)

外壳底座: 开孔安装

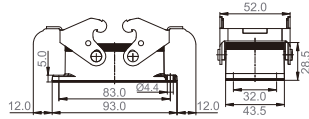

外壳底座: 表面安装

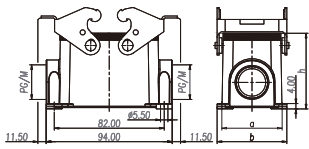

结构	a	b	h
低结构	40	52	61
高结构	45	57	76

低结构
~ 进线孔
高结构
~ 进线孔

Metr.	PG	型号	订货号
		H10B-AG H10B-AGS	T 1 41 010 2000-000 T 1 41 010 1000-000
M20	PG16	H10B-SGR-PG16	T 1 44 010 2116-000
M25	PG21	H10B-SGR-PG21	T 1 44 010 2121-000
		H10B-SGR-M20	T 1 44 010 2120-000
		H10B-SGR-M25	T 1 44 010 2125-000
	PG16	H10B-SGR-2PG16	T 1 44 010 2216-000
	PG21	H10B-SGR-2PG21	T 1 44 010 2221-000
M20		H10B-SGR-2M20	T 1 44 010 2220-000
M25		H10B-SGR-2M25	T 1 44 010 2225-000
	PG21	H10B-SGRH-PG21	T 1 47 010 2121-000
	PG29	H10B-SGRH-PG29	T 1 47 010 2129-000
M25		H10B-SGRH-M25	T 1 47 010 2125-000
M32		H10B-SGRH-M32	T 1 47 010 2132-000
	PG21	H10B-SGRH-2PG21	T 1 47 010 2221-000
	PG29	H10B-SGRH-2PG29	T 1 47 010 2229-000
M25		H10B-SGRH-2M25	T 1 47 010 2225-000
M32		H10B-SGRH-2M32	T 1 47 010 2232-000

侧出带双扣上壳

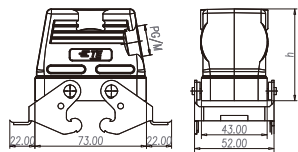

结构	h
低结构	60
高结构	72

低结构
高结构

顶出带双扣上壳

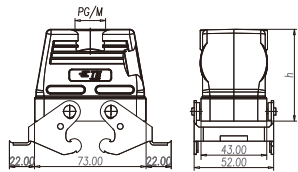

结构	h
低结构	60
高结构	72

低结构
高结构

四耳带盖开孔底座

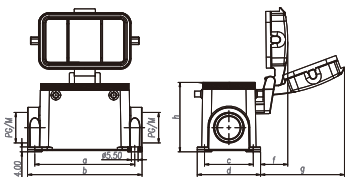
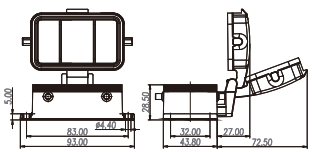

结构	a	b	c	d	f	g	h
低结构	82	94	40	52	22	67	61
高结构	82	94	45	57	20	65	76

低结构
~ 进线孔
高结构
~ 进线孔

		H10B-AD-BO	T 1 43 010 0000-000
M20	PG16	H10B-SDR-BO-PG16	T 1 46 010 0116-000
M25	PG21	H10B-SDR-BO-PG21	T 1 46 010 0121-000
		H10B-SDR-BO-M20	T 1 46 010 0120-000
		H10B-SDR-BO-M25	T 1 46 010 0125-000
	PG16	H10B-SDR-BO-2PG16	T 1 46 010 0216-000
	PG21	H10B-SDR-BO-2PG21	T 1 46 010 0221-000
M20		H10B-SDR-BO-2M20	T 1 46 010 0220-000
M25		H10B-SDR-BO-2M25	T 1 46 010 0225-000
	PG21	H10B-SDRH-BO-PG21	T 1 49 010 0121-000
	PG29	H10B-SDRH-BO-PG29	T 1 49 010 0129-000
M25		H10B-SDRH-BO-M25	T 1 49 010 0125-000
M32		H10B-SDRH-BO-M32	T 1 49 010 0132-000
	PG21	H10B-SDRH-BO-2PG21	T 1 49 010 0221-000
	PG29	H10B-SDRH-BO-2PG29	T 1 49 010 0229-000
M25		H10B-SDRH-BO-2M25	T 1 49 010 0225-000
M32		H10B-SDRH-BO-2M32	T 1 49 010 0232-000

H10B 带双扣外壳

表面粉末镀层, RAL 7037

外型尺寸 (mm)

外壳上壳侧面进线



低结构

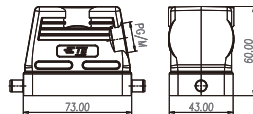

高结构

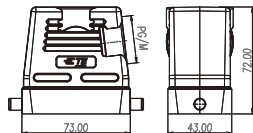

外壳上壳:顶部进线



低结构

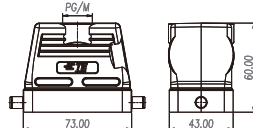

高结构

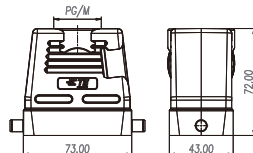

电缆对接下壳

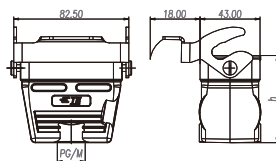

低结构

高结构

结构	h
低结构	62.5
高结构	74.5

上壳保护壳

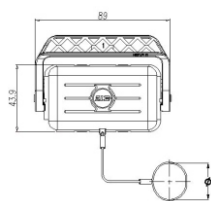

Metr.	PG	型号	订货号
M20 M25	PG16	H10B-TS-RO-PG16	T 1 31 010 0116-000
	PG21	H10B-TS-RO-PG21	T 1 31 010 0121-000
		H10B-TS-RO-M20	T 1 31 010 0120-000
		H10B-TS-RO-M25	T 1 31 010 0125-000
M20 M25 M32	PG21	H10B-TSH-RO-PG21	T 1 33 010 0121-000
	PG29	H10B-TSH-RO-PG29	T 1 33 010 0129-000
		H10B-TSH-RO-M20	T 1 33 010 0120-000
		H10B-TSH-RO-M25	T 1 33 010 0125-000
		H10B-TSH-RO-M32	T 1 33 010 0132-000
M20 M25	PG16	H10B-TG-RO-PG16	T 1 32 010 0116-000
	PG21	H10B-TG-RO-PG21	T 1 32 010 0121-000
		H10B-TG-RO-M20	T 1 32 010 0120-000
		H10B-TG-RO-M25	T 1 32 010 0125-000
M20 M25 M32	PG21	H10B-TGH-RO-PG21	T 1 34 010 0121-000
	PG29	H10B-TGH-RO-PG29	T 1 34 010 0129-000
		H10B-TGH-RO-M20	T 1 34 010 0120-000
		H10B-TGH-RO-M25	T 1 34 010 0125-000
		H10B-TGH-RO-M32	T 1 34 010 0132-000
M20 M25	PG16	H10B-TBF-LB-PG16	T 1 73 010 3116-000
		H10B-TBF-LB-M20	T 1 73 010 3120-000
		H10B-TBF-LB-M25	T 1 73 010 3125-000
	PG21	H10B-TBFH-LB-PG21	T 1 77 010 3121-000
	H10B-TBFH-LB-PG29	T 1 77 010 3129-000	
M20		H10B-TBFH-LB-M25	T 1 77 010 3125-000
M25		H10B-TBFH-LB-M32	T 1 77 010 3132-000
		H10B-KDTP-LB	T 1 01 010 1500-000

H10B 带单扣外壳

表面粉末镀层, RAL 7037

外型尺寸 (mm)

外壳底座:开孔安装

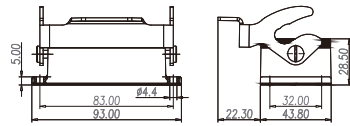

带保护盖

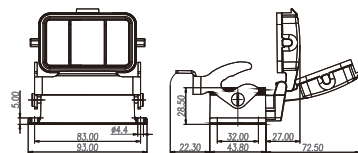

外壳底座:表面安装

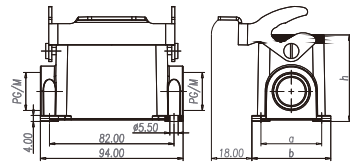

结构	a	b	h
低结构	40	52	61
高结构	45	57	76

低结构
~ 进线孔
高结构
~ 进线孔



带保护盖

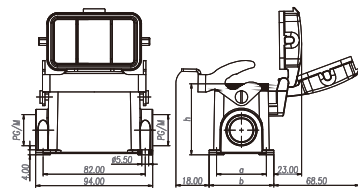

结构	a	b	h
低结构	40	52	61
高结构	45	57	76

低结构
~ 进线孔
高结构
~ 进线孔

Metr.	PG	型号	订货号
		H10B-AG-LB	T 1 50 010 3000-000
		H10B-AD-LB H10B-ADM-LB	T 1 51 010 3000-000 T 1 51 010 3001-000
M20 M25	PG16 PG21	H10B-SGR-LB-PG16 H10B-SGR-LB-PG21 H10B-SGR-LB-M20 H10B-SGR-LB-M25	T 1 61 010 3116-000 T 1 61 010 3121-000 T 1 61 010 3120-000 T 1 61 010 3125-000
M20 M25	PG16 PG21	H10B-SGR-LB-2PG16 H10B-SGR-LB-2PG21 H10B-SGR-LB-2M20 H10B-SGR-LB-2M25	T 1 61 010 3216-000 T 1 61 010 3221-000 T 1 61 010 3220-000 T 1 61 010 3225-000
M25 M32	PG21 PG29	H10B-SGRH-LB-PG21 H10B-SGRH-LB-PG29 H10B-SGRH-LB-M25 H10B-SGRH-LB-M32	T 1 65 010 3121-000 T 1 65 010 3129-000 T 1 65 010 3125-000 T 1 65 010 3132-000
M25 M32	PG21 PG29	H10B-SGRH-LB-2PG21 H10B-SGRH-LB-2PG29 H10B-SGRH-LB-2M25 H10B-SGRH-LB-2M32	T 1 65 010 3221-000 T 1 65 010 3229-000 T 1 65 010 3225-000 T 1 65 010 3232-000
M20 M25	PG16 PG21	H10B-SDR-LB-PG16 H10B-SDR-LB-PG21 H10B-SDR-LB-M20 H10B-SDR-LB-M25	T 1 62 010 3116-000 T 1 62 010 3121-000 T 1 62 010 3120-000 T 1 62 010 3125-000
M20 M25	PG16 PG21	H10B-SDR-LB-2PG16 H10B-SDR-LB-2PG21 H10B-SDR-LB-2M20 H10B-SDR-LB-2M25	T 1 62 010 3216-000 T 1 62 010 3221-000 T 1 62 010 3220-000 T 1 62 010 3225-000
M25 M32	PG21 PG29	H10B-SDRH-LB-PG21 H10B-SDRH-LB-PG29 H10B-SDRH-LB-M25 H10B-SDRH-LB-M32	T 1 66 010 3121-000 T 1 66 010 3129-000 T 1 66 010 3125-000 T 1 66 010 3132-000
M25 M32	PG21 PG29	H10B-SDRH-LB-2PG21 H10B-SDRH-LB-2PG29 H10B-SDRH-LB-2M25 H10B-SDRH-LB-2M32	T 1 66 010 3221-000 T 1 66 010 3229-000 T 1 66 010 3225-000 T 1 66 010 3232-000

HD-040 接插体

芯件适配 H16B 外壳, RAL 7037

40+ ⊕ (车针)

250V 10A

外型尺寸 (mm)

冷压接 (冷压针需单独订购)

1) 接插体之间最大距离24mm

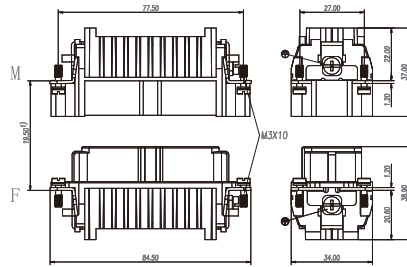

不使用防护外壳时芯体的安装开孔图

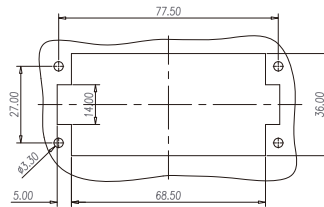

接插针排序

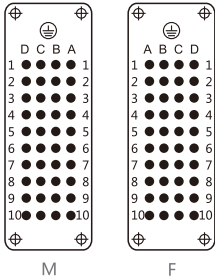

公接插件	订货号		型号
	母接插件		
		T 2 02 040 2101-000	HD-040-M
		T 2 02 040 2201-000	HD-040-F

插针

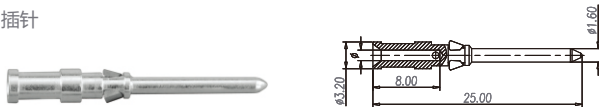

线规	剥线长度	镀银冷压接插针		镀金冷压接插针		
		型号	订货号	型号	订货号	
0.14mm ²	AWG26-22	8.0mm	CDM-0.14	T 2 02 000 1002-000	DDM-0.14	T 2 02 001 1002-000
0.5mm ²	AWG20	8.0mm	CDM-0.5	T 2 02 000 1005-000	DDM-0.5	T 2 02 001 1005-000
0.75mm ²	AWG18	8.0mm	CDM-0.75	T 2 02 000 1008-000	DDM-0.75	T 2 02 001 1008-000
1.0mm ²	AWG18	8.0mm	CDM-1.0	T 2 02 000 1010-000	DDM-1.0	T 2 02 001 1010-000
1.5mm ²	AWG16	8.0mm	CDM-1.5	T 2 02 000 1015-000	DDM-1.5	T 2 02 001 1015-000
2.5mm ²	AWG14	6.0mm	CDM-2.5	T 2 02 000 1025-000	DDM-2.5	T 2 02 001 1025-000

插孔



线规	剥线长度	镀银冷压接插针		镀金冷压接插针		
		型号	订货号	型号	订货号	
0.14mm ²	AWG26-22	8.0mm	CDF-0.14	T 2 02 000 2002-000	DDF-0.14	T 2 02 001 2002-000
0.5mm ²	AWG20	8.0mm	CDF-0.5	T 2 02 000 2005-000	DDF-0.5	T 2 02 001 2005-000
0.75mm ²	AWG18	8.0mm	CDF-0.75	T 2 02 000 2008-000	DDF-0.75	T 2 02 001 2008-000
1.0mm ²	AWG18	8.0mm	CDF-1.0	T 2 02 000 2010-000	DDF-1.0	T 2 02 001 2010-000
1.5mm ²	AWG16	8.0mm	CDF-1.5	T 2 02 000 2015-000	DDF-1.5	T 2 02 001 2015-000
2.5mm ²	AWG14	6.0mm	CDF-2.5	T 2 02 000 2025-000	DDF-2.5	T 2 02 001 2025-000

HD-040 接插体

芯件适配 H16B 外壳

40+ \oplus (冷压针:卷针)

250V 10A

外型尺寸 (mm)

卷皮式冷压接 (冷压针需单独订购)

1) 接插体之间最大距离24mm

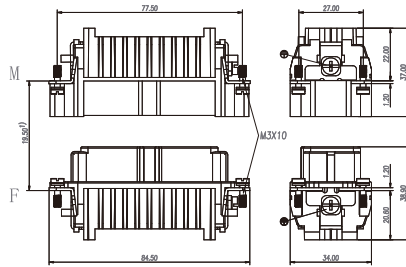

接插针排序

不使用防护外壳时芯体的安装开孔图

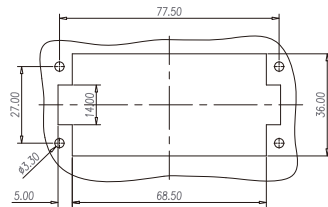
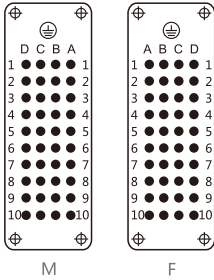

公接插件	订货号		型号
	公接插件	母接插件	
	T 2 02 040 2101-000		HD-040-M
		T T2020402201-100	HD-040-FJ

插针

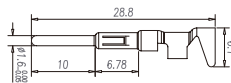

线规	剥线长度	镀银冷压接插针		镀金冷压接插针	
		型号	订货号	型号	订货号
0.14-0.5mm ²	AWG26-20	CJM-14	T 2 20 000 1005-000	DJM-14	T 2 20 001 1005-000
0.5-1.5mm ²	AWG20-16	CJM-50	T 2 20 000 1010-000	DJM-50	T 2 20 001 1010-000
1.5-2.5mm ²	AWG16-14	CJM-150	T 2 20 000 1025-000	DJM-150	T 2 20 001 1025-000

插孔

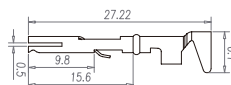

线规	剥线长度	镀银冷压接插针		镀金冷压接插针	
		型号	订货号	型号	订货号
0.14-0.5mm ²	AWG26-20	CJF-14	T 2 20 000 2005-000	DJF-14	T 2 20 001 2005-000
0.5-1.5mm ²	AWG20-16	CJF-50	T 2 20 000 2010-000	DJF-50	T 2 20 001 2010-000
1.5-2.5mm ²	AWG16-14	CJF-150	T 2 20 000 2025-000	DJF-150	T 2 20 001 2025-000

HDD-072 接插体

芯件适配 H16B 外壳

72+⊕ (车针)

250V 10A

外型尺寸 (mm)

冷压接 (冷压针需单独订购)

接插体之间最大距离24mm

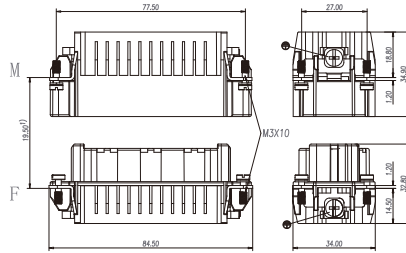

外型尺寸 (mm)	订货号		型号
	公接插件	母接插件	
冷压接 (冷压针需单独订购)	T 2 03 072 2101-000		HDD-072-M
		T 2 03 072 2201-000	HDD-072-F

接插针排序

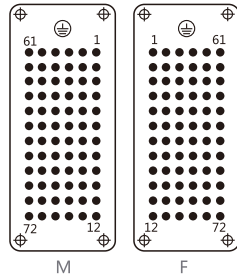

不使用防护外壳时芯体的安装开孔图

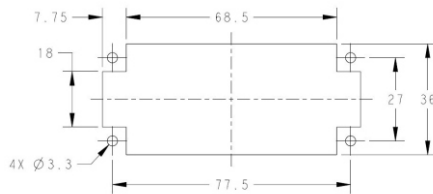

插针

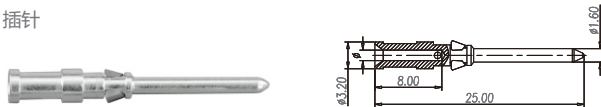

线规	剥线长度	镀银冷压接插针		镀金冷压接插针		
		型号	订货号	型号	订货号	
0.14mm ²	AWG26-22	8.0mm	CDM-0.14	T 2 02 000 1002-000	DDM-0.14	T 2 02 001 1002-000
0.5mm ²	AWG20	8.0mm	CDM-0.5	T 2 02 000 1005-000	DDM-0.5	T 2 02 001 1005-000
0.75mm ²	AWG18	8.0mm	CDM-0.75	T 2 02 000 1008-000	DDM-0.75	T 2 02 001 1008-000
1.0mm ²	AWG18	8.0mm	CDM-1.0	T 2 02 000 1010-000	DDM-1.0	T 2 02 001 1010-000
1.5mm ²	AWG16	8.0mm	CDM-1.5	T 2 02 000 1015-000	DDM-1.5	T 2 02 001 1015-000
2.5mm ²	AWG14	6.0mm	CDM-2.5	T 2 02 000 1025-000	DDM-2.5	T 2 02 001 1025-000











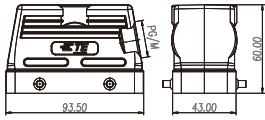

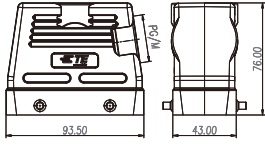
插孔

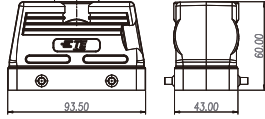

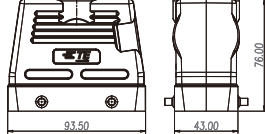
线规	剥线长度	镀银冷压接插针		镀金冷压接插针		
		型号	订货号	型号	订货号	
0.14mm ²	AWG26-22	8.0mm	CDF-0.14	T 2 02 000 2002-000	DDF-0.14	T 2 02 001 2002-000
0.5mm ²	AWG20	8.0mm	CDF-0.5	T 2 02 000 2005-000	DDF-0.5	T 2 02 001 2005-000
0.75mm ²	AWG18	8.0mm	CDF-0.75	T 2 02 000 2008-000	DDF-0.75	T 2 02 001 2008-000
1.0mm ²	AWG18	8.0mm	CDF-1.0	T 2 02 000 2010-000	DDF-1.0	T 2 02 001 2010-000
1.5mm ²	AWG16	8.0mm	CDF-1.5	T 2 02 000 2015-000	DDF-1.5	T 2 02 001 2015-000
2.5mm ²	AWG14	6.0mm	CDF-2.5	T 2 02 000 2025-000	DDF-2.5	T 2 02 001 2025-000

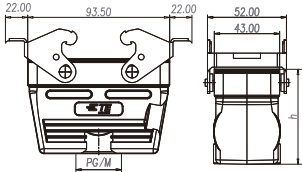

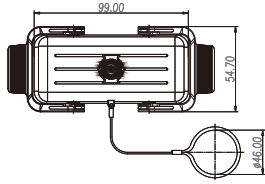

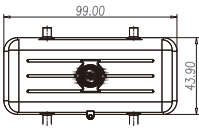

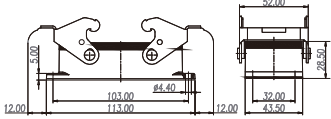
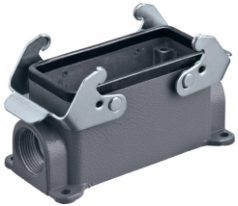
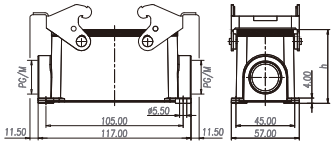

H16B 带双扣外壳

芯件适配 H16B 外壳

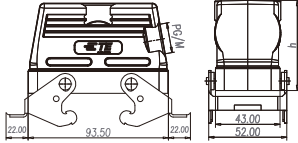
外型尺寸 (mm)	Metr.	PG	型号	订货号						
<p>外壳上壳侧面进线</p>  <p>低结构</p> 	M25 M32	PG16 PG21	H16B-TS-PG16 H16B-TS-PG21	T 1 21 016 0116-000 T 1 21 016 0121-000						
 <p>高结构</p> 			PG21 PG29	H16B-TSH-PG21 H16B-TSH-PG29	T 1 23 016 0121-000 T 1 23 016 0129-000					
<p>外壳上壳:顶部进线</p>  <p>低结构</p> 	M25 M32	PG16 PG21	H16B-TG-PG16 H16B-TG-PG21	T 1 22 016 0116-000 T 1 22 016 0121-000						
 <p>高结构</p> 			PG21 PG29	H16B-TGH-PG21 H16B-TGH-PG29	T 1 24 016 0121-000 T 1 24 016 0129-000					
<p>电缆对接下壳</p>  <p>低结构</p>  <table border="1" data-bbox="649 1521 836 1594"> <tr> <td>结构</td> <td>h</td> </tr> <tr> <td>低结构</td> <td>62.5</td> </tr> <tr> <td>高结构</td> <td>78.5</td> </tr> </table> <p>高结构</p>	结构	h	低结构	62.5	高结构	78.5	M25 M32	PG21 PG29	H16B-TBF-PG21 H16B-TBF-M25 H16B-TBF-M32 H16B-TBFH-PG21 H16B-TBFH-PG29 H16B-TBFH-M25 H16B-TBFH-M32 H16B-TBFH-M40	T 1 71 016 2121-000 T 1 71 016 2125-000 T 1 71 016 2132-000 T 1 75 016 2121-000 T 1 75 016 2129-000 T 1 75 016 2125-000 T 1 75 016 2132-000 T 1 75 016 2140-000
结构	h									
低结构	62.5									
高结构	78.5									
<p>上壳保护壳</p>  			H16B-KDTP	T 1 01 016 1400-000						
<p>底座保护壳</p>  			H16B-KDBP	T 1 01 016 2100-000						

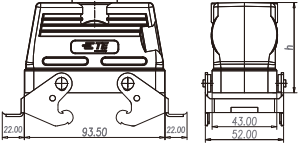

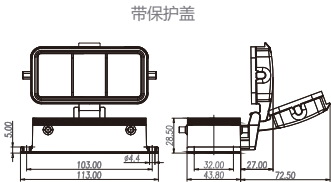

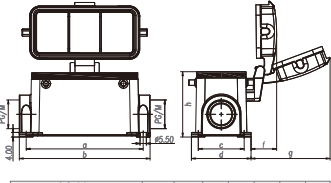



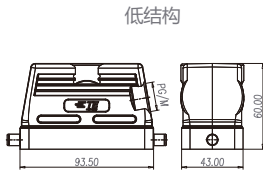

H16B 带双扣外壳

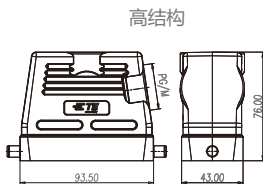
表面粉末镀层, RAL 7037

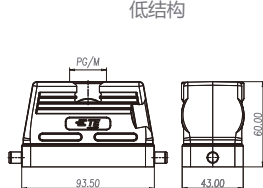
外型尺寸 (mm)	Metr.	PG	型号	订货号																								
外壳底座: 开孔安装  			H16B-AG H16B-AGS	T 1 41 016 2000-000 T 1 41 016 1000-000																								
外壳底座: 表面安装   <table border="1" data-bbox="667 868 829 943"> <tr><td>结构</td><td>h</td></tr> <tr><td>低结构</td><td>56</td></tr> <tr><td>高结构</td><td>76</td></tr> </table>	结构	h	低结构	56	高结构	76	M25	PG21	H16B-SGR-PG21	T 1 44 016 2121-000																		
结构	h																											
低结构	56																											
高结构	76																											
	M25	PG21	H16B-SGR-M25	T 1 44 016 2125-000																								
	M25	PG21	H16B-SGR-2PG21	T 1 44 016 2221-000																								
	M25	PG21	H16B-SGR-2M25	T 1 44 016 2225-000																								
	M25	PG29	H16B-SGRH-PG21	T 1 47 016 2121-000																								
	M25	PG29	H16B-SGRH-PG29	T 1 47 016 2129-000																								
	M32	PG21	H16B-SGRH-M25	T 1 47 016 2125-000																								
	M32	PG21	H16B-SGRH-M32	T 1 47 016 2132-000																								
	M25	PG21	H16B-SGRH-2PG21	T 1 47 016 2221-000																								
	M25	PG29	H16B-SGRH-2PG29	T 1 47 016 2229-000																								
	M32	PG21	H16B-SGRH-2M25	T 1 47 016 2225-000																								
	M32	PG29	H16B-SGRH-2M32	T 1 47 016 2232-000																								
侧出带双扣上壳   <table border="1" data-bbox="659 1129 821 1204"> <tr><td>结构</td><td>h</td></tr> <tr><td>低结构</td><td>60</td></tr> <tr><td>高结构</td><td>76</td></tr> </table>	结构	h	低结构	60	高结构	76	M20	PG16	H16B-TSB-PG16	T 1 25 016 2116-000																		
结构	h																											
低结构	60																											
高结构	76																											
	M25	PG21	H16B-TSB-PG21	T 1 25 016 2121-000																								
	M25	PG21	H16B-TSB-M20	T 1 25 016 2120-000																								
	M25	PG21	H16B-TSB-M25	T 1 25 016 2125-000																								
	M25	PG29	H16B-TSBH-PG21	T 1 27 016 2121-000																								
	M32	PG29	H16B-TSBH-PG29	T 1 27 016 2129-000																								
	M32	PG29	H16B-TSBH-M25	T 1 27 016 2125-000																								
	M32	PG29	H16B-TSBH-M32	T 1 27 016 2132-000																								
顶出带双扣上壳   <table border="1" data-bbox="659 1378 821 1453"> <tr><td>结构</td><td>h</td></tr> <tr><td>低结构</td><td>60</td></tr> <tr><td>高结构</td><td>76</td></tr> </table>	结构	h	低结构	60	高结构	76	M20	PG16	H16B-TGB-PG16	T 1 26 016 2116-000																		
结构	h																											
低结构	60																											
高结构	76																											
	M25	PG21	H16B-TGB-PG21	T 1 26 016 2121-000																								
	M25	PG21	H16B-TGB-M20	T 1 26 016 2120-000																								
	M25	PG21	H16B-TGB-M25	T 1 26 016 2125-000																								
	M25	PG29	H16B-TGBH-PG21	T 1 28 016 2121-000																								
	M32	PG29	H16B-TGBH-PG29	T 1 28 016 2129-000																								
	M32	PG29	H16B-TGBH-M25	T 1 28 016 2125-000																								
	M32	PG29	H16B-TGBH-M32	T 1 28 016 2132-000																								
四耳带盖开孔底座   <p>带保护盖</p>			H16B-AD-BO	T 1 43 016 0000-000																								
  <table border="1" data-bbox="516 1986 834 2057"> <tr><td>结构</td><td>a</td><td>b</td><td>c</td><td>d</td><td>f</td><td>g</td><td>h</td></tr> <tr><td>低结构</td><td>105</td><td>117</td><td>45</td><td>57</td><td>20</td><td>65</td><td>56</td></tr> <tr><td>高结构</td><td>105</td><td>117</td><td>45</td><td>57</td><td>20</td><td>65</td><td>76</td></tr> </table>	结构	a	b	c	d	f	g	h	低结构	105	117	45	57	20	65	56	高结构	105	117	45	57	20	65	76	M25	PG21	H16B-SDR-BO-PG21	T 1 46 016 0121-000
结构	a	b	c	d	f	g	h																					
低结构	105	117	45	57	20	65	56																					
高结构	105	117	45	57	20	65	76																					
	M25	PG21	H16B-SDR-BO-M25	T 1 46 016 0125-000																								
	M25	PG21	H16B-SDR-BO-2PG21	T 1 46 016 0221-000																								
	M25	PG21	H16B-SDR-BO-2M25	T 1 46 016 0225-000																								
	M25	PG29	H16B-SDRH-BO-PG21	T 1 49 016 0121-000																								
	M25	PG29	H16B-SDRH-BO-PG29	T 1 49 016 0129-000																								
	M32	PG21	H16B-SDRH-BO-M25	T 1 49 016 0125-000																								
	M32	PG21	H16B-SDRH-BO-M32	T 1 49 016 0132-000																								
	M32	PG21	H16B-SDRH-BO-2PG21	T 1 49 016 0221-000																								
	M32	PG29	H16B-SDRH-BO-2PG29	T 1 49 016 0229-000																								
	M32	PG29	H16B-SDRH-BO-2M25	T 1 49 016 0225-000																								
	M32	PG29	H16B-SDRH-BO-2M32	T 1 49 016 0232-000																								

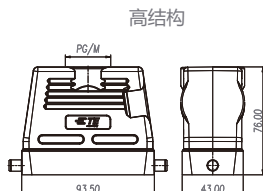
H16B 带单扣外壳

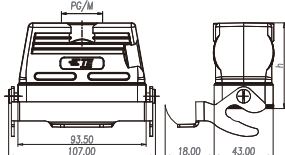
表面粉末镀层, RAL 7037

外型尺寸 (mm)	Metr.	PG	型号	订货号				
<p>外壳上壳:侧面进线</p> 	M25 M32	PG21 PG29	H16B-TS-RO-PG21 H16B-TS-RO-PG29	T 1 31 016 0121-000 T 1 31 016 0129-000				
<p>低结构</p> 			H16B-TS-RO-M25 H16B-TS-RO-M32	T 1 31 016 0125-000 T 1 31 016 0132-000				
	M25 M32 M40	PG21 PG29	H16B-TSH-RO-PG21 H16B-TSH-RO-PG29	T 1 33 016 0121-000 T 1 33 016 0129-000				
<p>高结构</p> 			H16B-TSH-RO-M25 H16B-TSH-RO-M32 H16B-TSH-RO-M40	T 1 33 016 0125-000 T 1 33 016 0132-000 T 1 33 016 0140-000				
<p>外壳上壳:顶面进线</p> 			M25 M32	PG21 PG29	H16B-TG-RO-PG21 H16B-TG-RO-PG29	T 1 32 016 0121-000 T 1 32 016 0129-000		
<p>低结构</p> 	H16B-TG-RO-M25 H16B-TG-RO-M32	T 1 32 016 0125-000 T 1 32 016 0132-000						
	M25 M32 M40	PG21 PG29	H16B-TGH-RO-PG21 H16B-TGH-RO-PG29	T 1 34 016 0121-000 T 1 34 016 0129-000				
<p>高结构</p> 			H16B-TGH-RO-M25 H16B-TGH-RO-M32 H16B-TGH-RO-M40	T 1 34 016 0125-000 T 1 34 016 0132-000 T 1 34 016 0140-000				
<p>电缆对接下壳</p> 			M25 M32	PG21 PG29	H16B-TBF-LB-PG21 H16B-TBF-LB-PG29 H16B-TBF-LB-M25 H16B-TBF-LB-M32	T 1 73 016 3121-000 T 1 73 016 3129-000 T 1 73 016 3125-000 T 1 73 016 3132-000		
<p>低结构</p>  <table border="1" data-bbox="656 1682 834 1759"> <tr> <td>结构</td> <td>h</td> </tr> <tr> <td>低结构</td> <td>62.5</td> </tr> <tr> <td>高结构</td> <td>78.5</td> </tr> </table>	结构	h			低结构	62.5	高结构	78.5
结构	h							
低结构	62.5							
高结构	78.5							
<p>上壳保护壳</p> 			H16B-KDTP-LB	T 1 01 016 1500-000				

H16B 带单扣外壳

表面粉末镀层, RAL 7037

外型尺寸 (mm)

外壳底座:开孔安装

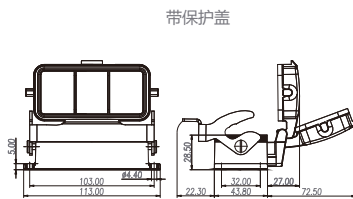
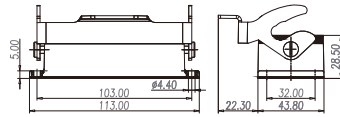

外壳底座:表面安装

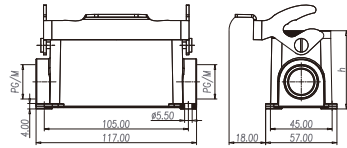

结构	h
低结构	56
高结构	76

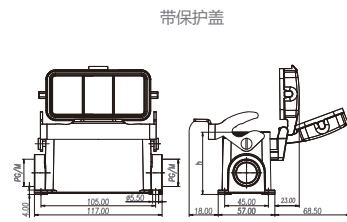

结构	h
低结构	56
高结构	76

Metr.	PG	型号	订货号	
		H16B-AG-LB	T 1 50 016 3000-000	
		H16B-AD-LB	T 1 51 016 3000-000	
M20 M25	PG16 PG21	H16B-SGR-LB-PG16	T 1 61 016 3116-000	
		H16B-SGR-LB-PG21	T 1 61 016 3121-000	
	PG16 PG21	H16B-SGR-LB-M20	T 1 61 016 3120-000	
		H16B-SGR-LB-M25	T 1 61 016 3125-000	
	M20 M25	PG16 PG21	H16B-SGR-LB-2PG16	T 1 61 016 3216-000
			H16B-SGR-LB-2PG21	T 1 61 016 3221-000
	M20 M25	PG16 PG21	H16B-SGR-LB-2M20	T 1 61 016 3220-000
			H16B-SGR-LB-2M25	T 1 61 016 3225-000
	M25 M32	PG21 PG29	H16B-SGRH-LB-PG21	T 1 65 016 3121-000
			H16B-SGRH-LB-PG29	T 1 65 016 3129-000
		PG21 PG29	H16B-SGRH-LB-M25	T 1 65 016 3125-000
			H16B-SGRH-LB-M32	T 1 65 016 3132-000
M25 M32		PG21 PG29	H16B-SGRH-LB-2PG21	T 1 65 016 3221-000
			H16B-SGRH-LB-2PG29	T 1 65 016 3229-000
M20 M25	PG16 PG21	H16B-SDR-LB-PG16	T 1 62 016 3116-000	
		H16B-SDR-LB-PG21	T 1 62 016 3121-000	
	PG16 PG21	H16B-SDR-LB-M20	T 1 62 016 3120-000	
		H16B-SDR-LB-M25	T 1 62 016 3125-000	
	M20 M25	PG16 PG21	H16B-SDR-LB-2PG16	T 1 62 016 3216-000
			H16B-SDR-LB-2PG21	T 1 62 016 3221-000
	M20 M25	PG16 PG21	H16B-SDR-LB-2M20	T 1 62 016 3220-000
			H16B-SDR-LB-2M25	T 1 62 016 3225-000
	M25 M32	PG21 PG29	H16B-SDRH-LB-PG21	T 1 66 016 3121-000
			H16B-SDRH-LB-PG29	T 1 66 016 3129-000
		PG21 PG29	H16B-SDRH-LB-M25	T 1 66 016 3125-000
			H16B-SDRH-LB-M32	T 1 66 016 3132-000
M25 M32		PG21 PG29	H16B-SDRH-LB-2PG21	T 1 66 016 3221-000
			H16B-SDRH-LB-2PG29	T 1 66 016 3229-000
M25 M32	PG21 PG29	H16B-SDRH-LB-2M25	T 1 66 016 3225-000	
		H16B-SDRH-LB-2M32	T 1 66 016 3232-000	

低结构 高结构
~ 进线孔 丁 进线孔
~ 进线孔 丁 进线孔
~ 进线孔 丁 进线孔

HD-064 接插体

芯件适配 H24B 外壳

64+ ⊕ (车针)

250V 10A

外型尺寸 (mm)

订货号
公接插件 母接插件 型号

冷压接 (冷压针需单独订购)

接插体之间最大距离24mm

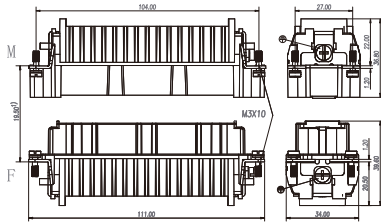

T 2 02 064 2101-000

HD-064-M

T 2 02 064 2201-000

HD-064-F

接插针排序

不使用防护外壳时芯体的安装开孔图

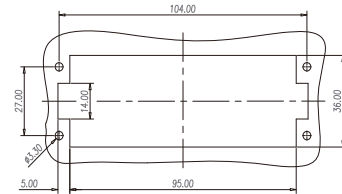
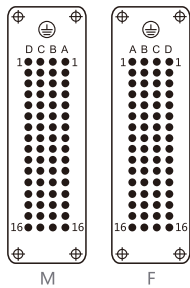

插针



线规	剥线长度	镀银冷压接插针		镀金冷压接插针		
		型号	订货号	型号	订货号	
0.14mm ²	AWG26-22	8.0mm	CDM-0.14	T 2 02 000 1002-000	DDM-0.14	T 2 02 001 1002-000
0.5mm ²	AWG20	8.0mm	CDM-0.5	T 2 02 000 1005-000	DDM-0.5	T 2 02 001 1005-000
0.75mm ²	AWG18	8.0mm	CDM-0.75	T 2 02 000 1008-000	DDM-0.75	T 2 02 001 1008-000
1.0mm ²	AWG18	8.0mm	CDM-1.0	T 2 02 000 1010-000	DDM-1.0	T 2 02 001 1010-000
1.5mm ²	AWG16	8.0mm	CDM-1.5	T 2 02 000 1015-000	DDM-1.5	T 2 02 001 1015-000
2.5mm ²	AWG14	6.0mm	CDM-2.5	T 2 02 000 1025-000	DDM-2.5	T 2 02 001 1025-000

插孔



线规	剥线长度	镀银冷压接插针		镀金冷压接插针		
		型号	订货号	型号	订货号	
0.14mm ²	AWG26-22	8.0mm	CDF-0.14	T 2 02 000 2002-000	DDF-0.14	T 2 02 001 2002-000
0.5mm ²	AWG20	8.0mm	CDF-0.5	T 2 02 000 2005-000	DDF-0.5	T 2 02 001 2005-000
0.75mm ²	AWG18	8.0mm	CDF-0.75	T 2 02 000 2008-000	DDF-0.75	T 2 02 001 2008-000
1.0mm ²	AWG18	8.0mm	CDF-1.0	T 2 02 000 2010-000	DDF-1.0	T 2 02 001 2010-000
1.5mm ²	AWG16	8.0mm	CDF-1.5	T 2 02 000 2015-000	DDF-1.5	T 2 02 001 2015-000
2.5mm ²	AWG14	6.0mm	CDF-2.5	T 2 02 000 2025-000	DDF-2.5	T 2 02 001 2025-000

HD-064 接插体

芯件适配 H24B 外壳

64+ ⊕ 冷压针:卷针

250V 10A

外型尺寸 (mm)

卷皮式冷压接 (冷压针需单独订购)

接插体之间最大距离24mm

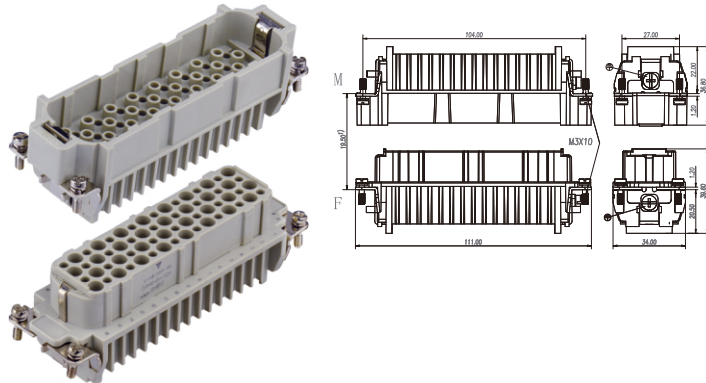

接插针排序

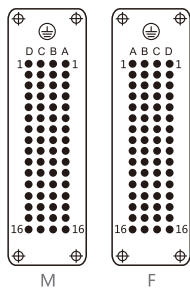

不使用防护外壳时芯体的安装开孔图

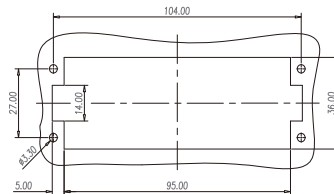

公接插件	母接插件	型号
T 2 02 064 2101-000		HD-064-M
	T 2 02 064 2201-100	HD-064-FJ

插针



线规	剥线长度	镀银冷压接插针		镀金冷压接插针	
		型号	订货号	型号	订货号
0.14-0.5mm ²	AWG26-20	CJM-14	T 2 20 000 1005-000	DJM-14	T 2 20 001 1005-000
0.5-1.5mm ²	AWG20-16	CJM-50	T 2 20 000 1010-000	DJM-50	T 2 20 001 1010-000
1.5-2.5mm ²	AWG16-14	CJM-150	T 2 20 000 1025-000	DJM-150	T 2 20 001 1025-000

插孔



线规	剥线长度	镀银冷压接插针		镀金冷压接插针	
		型号	订货号	型号	订货号
0.14-0.5mm ²	AWG26-20	CJF-14	T 2 20 000 2005-000	DJF-14	T 2 20 001 2005-000
0.5-1.5mm ²	AWG20-16	CJF-50	T 2 20 000 2010-000	DJF-50	T 2 20 001 2010-000
1.5-2.5mm ²	AWG16-14	CJF-150	T 2 20 000 2025-000	DJF-150	T 2 20 001 2025-000

HDD-108 接插体

芯件适配 H24B 外壳

108+  车针

250V 10A

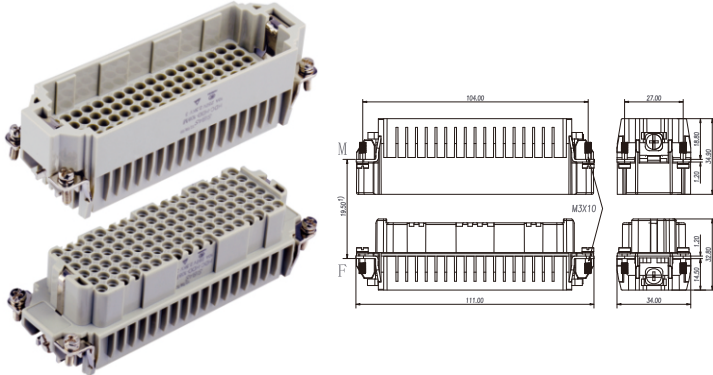
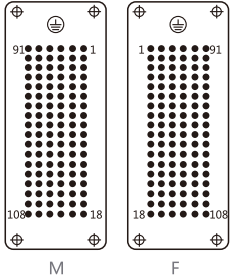
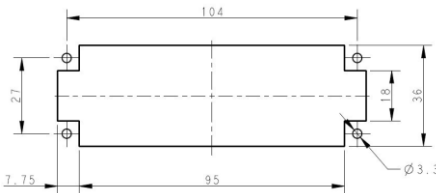
外型尺寸 (mm)	订货号		型号
	公接插件	母接插件	
<p>冷压接 (冷压针需单独订购)</p> <p>接插体之间最大距离24mm</p>  <p>接插针排序</p>  <p>不使用防护外壳时芯体的安装开孔图</p> 	T 2 03 108 2101-000	T 2 03 108 2201-000	HD-108-M HD-108-F

插针

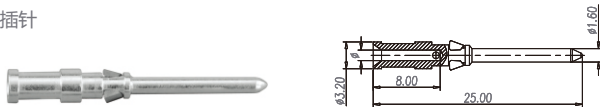

线规	剥线长度	镀银冷压接插针		镀金冷压接插针		
		型号	订货号	型号	订货号	
0.14mm ²	AWG26-22	8.0mm	CDM-0.14	T 2 02 000 1002-000	DDM-0.14	T 2 02 001 1002-000
0.5mm ²	AWG20	8.0mm	CDM-0.5	T 2 02 000 1005-000	DDM-0.5	T 2 02 001 1005-000
0.75mm ²	AWG18	8.0mm	CDM-0.75	T 2 02 000 1008-000	DDM-0.75	T 2 02 001 1008-000
1.0mm ²	AWG18	8.0mm	CDM-1.0	T 2 02 000 1010-000	DDM-1.0	T 2 02 001 1010-000
1.5mm ²	AWG16	8.0mm	CDM-1.5	T 2 02 000 1015-000	DDM-1.5	T 2 02 001 1015-000
2.5mm ²	AWG14	6.0mm	CDM-2.5	T 2 02 000 1025-000	DDM-2.5	T 2 02 001 1025-000











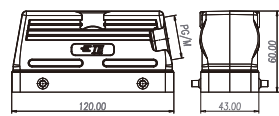
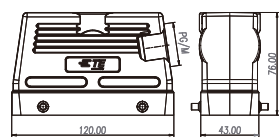

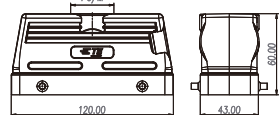
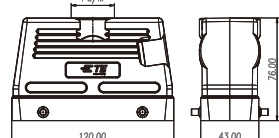
插孔

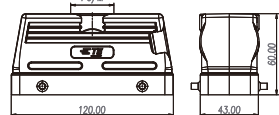
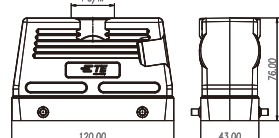

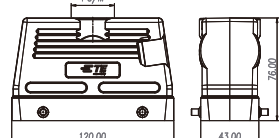
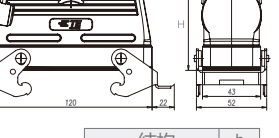
线规	剥线长度	镀银冷压接插针		镀金冷压接插针		
		型号	订货号	型号	订货号	
0.14mm ²	AWG26-22	8.0mm	CDF-0.14	T 2 02 000 2002-000	DDF-0.14	T 2 02 001 2002-000
0.5mm ²	AWG20	8.0mm	CDF-0.5	T 2 02 000 2005-000	DDF-0.5	T 2 02 001 2005-000
0.75mm ²	AWG18	8.0mm	CDF-0.75	T 2 02 000 2008-000	DDF-0.75	T 2 02 001 2008-000
1.0mm ²	AWG18	8.0mm	CDF-1.0	T 2 02 000 2010-000	DDF-1.0	T 2 02 001 2010-000
1.5mm ²	AWG16	8.0mm	CDF-1.5	T 2 02 000 2015-000	DDF-1.5	T 2 02 001 2015-000
2.5mm ²	AWG14	6.0mm	CDF-2.5	T 2 02 000 2025-000	DDF-2.5	T 2 02 001 2025-000

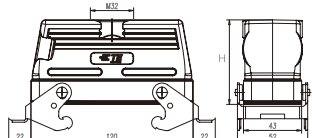

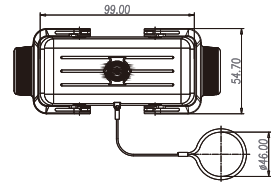

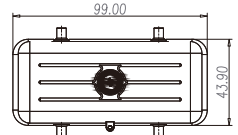

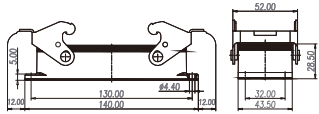
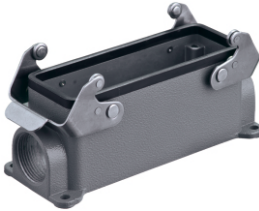
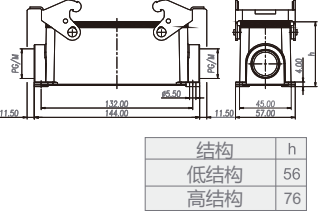

H24B 带双扣外壳

表面粉末镀层, RAL 7037

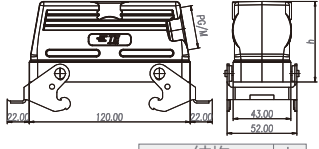
外型尺寸 (mm)	Metr.	PG	型号	订货号						
<p>外壳上壳:侧面进线</p>  <div style="display: flex; justify-content: space-around;"> <div style="text-align: center;"> <p>低结构</p>  </div> <div style="text-align: center;"> <p>高结构</p>  </div> </div>	M25 M32	PG16 PG21	H24B-TS-PG16 H24B-TS-PG21 H24B-TS-M25 H24B-TS-M32	T 1 21 024 0116-000 T 1 21 024 0121-000 T 1 21 024 0125-000 T 1 21 024 0132-000						
 <div style="display: flex; justify-content: space-around;"> <div style="text-align: center;"> <p>低结构</p>  </div> <div style="text-align: center;"> <p>高结构</p>  </div> </div>	M25 M32 M40	PG21 PG29	H24B-TSH-PG21 H24B-TSH-PG29 H24B-TSH-M25 H24B-TSH-M32 H24B-TSH-M40	T 1 23 024 0121-000 T 1 23 024 0129-000 T 1 23 024 0125-000 T 1 23 024 0132-000 T 1 23 024 0140-000						
<p>外壳上壳:顶面进线</p>  <div style="display: flex; justify-content: space-around;"> <div style="text-align: center;"> <p>低结构</p>  </div> <div style="text-align: center;"> <p>高结构</p>  </div> </div>	M25 M32	PG16 PG21	H24B-TG-PG16 H24B-TG-PG21 H24B-TG-M25 H24B-TG-M32	T 1 22 024 0116-000 T 1 22 024 0121-000 T 1 22 024 0125-000 T 1 22 024 0132-000						
 <div style="display: flex; justify-content: space-around;"> <div style="text-align: center;"> <p>低结构</p>  </div> <div style="text-align: center;"> <p>高结构</p>  </div> </div>	M25 M32 M40	PG21 PG29	H24B-TGH-PG21 H24B-TGH-PG29 H24B-TGH-M25 H24B-TGH-M32 H24B-TGH-M40	T 1 24 024 0121-000 T 1 24 024 0129-000 T 1 24 024 0125-000 T 1 24 024 0132-000 T 1 24 024 0140-000						
<p>电缆对接下壳</p>  <div style="display: flex; justify-content: space-around;"> <div style="text-align: center;">  </div> <div style="text-align: center;"> <p>低结构</p> </div> <div style="text-align: center;"> <p>高结构</p> </div> </div> <table border="1" style="margin-left: auto; margin-right: auto;"> <tr> <td>结构</td> <td>h</td> </tr> <tr> <td>低结构</td> <td>62.5</td> </tr> <tr> <td>高结构</td> <td>78.5</td> </tr> </table>	结构	h	低结构	62.5	高结构	78.5	M25 M32	PG21 PG21 PG29	H24B-TBF-PG21 H24B-TBF-M25 H24B-TBF-M32 H24B-TBFH-PG21 H24B-TBFH-PG29 H24B-TBFH-M25 H24B-TBFH-M32 H24B-TBFH-M40	T 1 71 024 2121-000 T 1 71 024 2125-000 T 1 71 024 2132-000 T 1 75 024 2121-000 T 1 75 024 2129-000 T 1 75 024 2125-000 T 1 75 024 2132-000 T 1 75 024 2140-000
结构	h									
低结构	62.5									
高结构	78.5									
<p>上壳保护壳</p>  			H24B-KDTP	T 1 01 024 1400-000						
<p>底座保护壳</p>  			H24B-KDBP	T 1 01 024 2100-000						

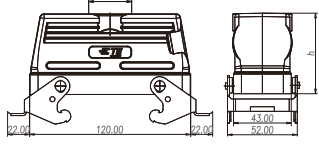
H24B 带双扣外壳

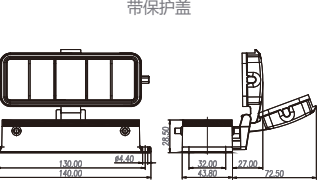
表面粉末镀层, RAL 7037

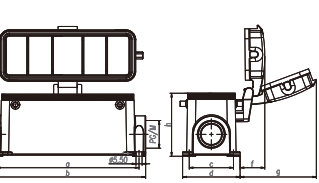
外型尺寸 (mm)	Metr.	PG	型号	订货号																								
<p>外壳底座: 开孔安装</p>  			H24B-AG	T 1 41 024 2000-000																								
<p>外壳底座: 表面安装</p>   <table border="1" data-bbox="654 870 813 943"> <tr><td>结构</td><td>h</td></tr> <tr><td>低结构</td><td>56</td></tr> <tr><td>高结构</td><td>76</td></tr> </table>	结构	h	低结构	56	高结构	76	<p>低结构</p> <p>高结构</p> <p>┌ 进线孔</p> <p>└ 进线孔</p> <p>┌ 进线孔</p> <p>└ 进线孔</p>	<p>PG21</p> <p>M25</p> <p>PG21</p> <p>M25</p> <p>PG21</p> <p>PG29</p> <p>M25</p> <p>M32</p> <p>PG21</p> <p>PG29</p> <p>M25</p> <p>M32</p>	<p>H24B-SGR-PG21</p> <p>H24B-SGR-M25</p> <p>H24B-SGR-2PG21</p> <p>H24B-SGR-2M25</p> <p>H24B-SGRH-PG21</p> <p>H24B-SGRH-PG29</p> <p>H24B-SGRH-M25</p> <p>H24B-SGRH-M32</p> <p>H24B-SGRH-2PG21</p> <p>H24B-SGRH-2PG29</p> <p>H24B-SGRH-2M25</p> <p>H24B-SGRH-2M32</p>	<p>T 1 44 024 2121-000</p> <p>T 1 44 024 2125-000</p> <p>T 1 44 024 2221-000</p> <p>T 1 44 024 2225-000</p> <p>T 1 47 024 2121-000</p> <p>T 1 47 024 2129-000</p> <p>T 1 47 024 2125-000</p> <p>T 1 47 024 2132-000</p> <p>T 1 47 024 2221-000</p> <p>T 1 47 024 2229-000</p> <p>T 1 47 024 2225-000</p> <p>T 1 47 024 2232-000</p>																		
结构	h																											
低结构	56																											
高结构	76																											
<p>侧出带双扣上壳</p>   <table border="1" data-bbox="654 1136 813 1204"> <tr><td>结构</td><td>h</td></tr> <tr><td>低结构</td><td>60</td></tr> <tr><td>高结构</td><td>76</td></tr> </table>	结构	h	低结构	60	高结构	76	<p>低结构</p> <p>高结构</p>	<p>PG16</p> <p>PG21</p> <p>M20</p> <p>M25</p> <p>PG21</p> <p>PG29</p> <p>M25</p> <p>M32</p>	<p>H24B-TSB-PG16</p> <p>H24B-TSB-PG21</p> <p>H24B-TSB-M20</p> <p>H24B-TSB-M25</p> <p>H24B-TSBH-PG21</p> <p>H24B-TSBH-PG29</p> <p>H24B-TSBH-M25</p> <p>H24B-TSBH-M32</p>	<p>T 1 25 024 2116-000</p> <p>T 1 25 024 2121-000</p> <p>T 1 25 024 2120-000</p> <p>T 1 25 024 2125-000</p> <p>T 1 27 024 2121-000</p> <p>T 1 27 024 2129-000</p> <p>T 1 27 024 2125-000</p> <p>T 1 27 024 2132-000</p>																		
结构	h																											
低结构	60																											
高结构	76																											
<p>顶出带双扣上壳</p>   <table border="1" data-bbox="654 1385 813 1453"> <tr><td>结构</td><td>h</td></tr> <tr><td>低结构</td><td>60</td></tr> <tr><td>高结构</td><td>76</td></tr> </table>	结构	h	低结构	60	高结构	76	<p>低结构</p> <p>高结构</p>	<p>PG16</p> <p>PG21</p> <p>M20</p> <p>M25</p> <p>PG21</p> <p>PG29</p> <p>M25</p> <p>M32</p>	<p>H24B-TGB-PG16</p> <p>H24B-TGB-PG21</p> <p>H24B-TGB-M20</p> <p>H24B-TGB-M25</p> <p>H24B-TGBH-PG21</p> <p>H24B-TGBH-PG29</p> <p>H24B-TGBH-M25</p> <p>H24B-TGBH-M32</p>	<p>T 1 26 024 2116-000</p> <p>T 1 26 024 2121-000</p> <p>T 1 26 024 2120-000</p> <p>T 1 26 024 2125-000</p> <p>T 1 28 024 2121-000</p> <p>T 1 28 024 2129-000</p> <p>T 1 28 024 2125-000</p> <p>T 1 28 024 2132-000</p>																		
结构	h																											
低结构	60																											
高结构	76																											
<p>四耳带盖开孔底座</p>   <p>带保护盖</p>   <table border="1" data-bbox="513 1986 813 2057"> <tr><td>结构</td><td>a</td><td>b</td><td>c</td><td>d</td><td>f</td><td>g</td><td>h</td></tr> <tr><td>低结构</td><td>132</td><td>144</td><td>45</td><td>57</td><td>20</td><td>65</td><td>56</td></tr> <tr><td>高结构</td><td>132</td><td>144</td><td>45</td><td>57</td><td>20</td><td>65</td><td>76</td></tr> </table>	结构	a	b	c	d	f	g	h	低结构	132	144	45	57	20	65	56	高结构	132	144	45	57	20	65	76	<p>低结构</p> <p>高结构</p> <p>┌ 进线孔</p> <p>└ 进线孔</p> <p>┌ 进线孔</p> <p>└ 进线孔</p>	<p>PG21</p> <p>M25</p> <p>PG21</p> <p>M25</p> <p>PG21</p> <p>PG29</p> <p>M25</p> <p>M32</p> <p>PG21</p> <p>PG29</p> <p>M25</p> <p>M32</p>	<p>H24B-AD-BO</p> <p>H24B-SDR-BO-PG21</p> <p>H24B-SDR-BO-M25</p> <p>H24B-SDR-BO-2PG21</p> <p>H24B-SDR-BO-2M25</p> <p>H24B-SDRH-BO-PG21</p> <p>H24B-SDRH-BO-PG29</p> <p>H24B-SDRH-BO-M25</p> <p>H24B-SDRH-BO-M32</p> <p>H24B-SDRH-BO-2PG21</p> <p>H24B-SDRH-BO-2PG29</p> <p>H24B-SDRH-BO-2M25</p> <p>H24B-SDRH-BO-2M32</p>	<p>T 1 43 024 0000-000</p> <p>T 1 46 024 0121-000</p> <p>T 1 46 024 0125-000</p> <p>T 1 46 024 0221-000</p> <p>T 1 46 024 0225-000</p> <p>T 1 49 024 0121-000</p> <p>T 1 49 024 0129-000</p> <p>T 1 49 024 0125-000</p> <p>T 1 49 024 0132-000</p> <p>T 1 49 024 0221-000</p> <p>T 1 49 024 0229-000</p> <p>T 1 49 024 0225-000</p> <p>T 1 49 024 0232-000</p>
结构	a	b	c	d	f	g	h																					
低结构	132	144	45	57	20	65	56																					
高结构	132	144	45	57	20	65	76																					

H24B 带单扣外壳

表面粉末镀层, RAL 7037

外型尺寸 (mm)

外壳上壳:侧面进线



低结构

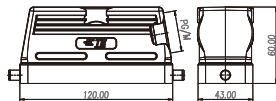

高结构

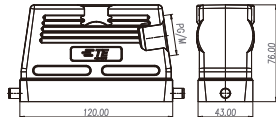

外壳上壳:顶面进线



低结构

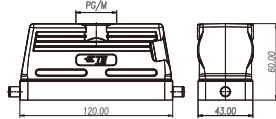

高结构

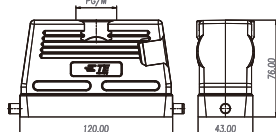

电缆对接下壳

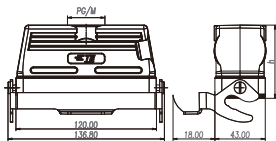

低结构

高结构

结构	h
低结构	62.5
高结构	78.5

上壳保护壳

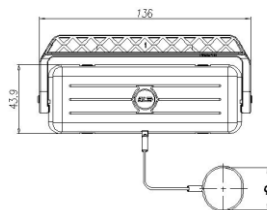

Metr.	PG	型号	订货号	
M25 M32	PG21 PG29	H24B-TS-RO-PG21	T 1 31 024 0121-000	
		H24B-TS-RO-PG29	T 1 31 024 0129-000	
	M25 M32	PG21 PG29	H24B-TS-RO-M25	T 1 31 024 0125-000
			H24B-TS-RO-M32	T 1 31 024 0132-000
M25 M32 M40	PG21 PG29	H24B-TSH-RO-PG21	T 1 33 024 0121-000	
		H24B-TSH-RO-PG29	T 1 33 024 0129-000	
	M25 M32 M40	PG21 PG29	H24B-TSH-RO-M25	T 1 33 024 0125-000
			H24B-TSH-RO-M32	T 1 33 024 0132-000
			H24B-TSH-RO-M40	T 1 33 024 0140-000
			H24B-TGH-RO-PG21	T 1 34 024 0121-000
M25 M32	PG21 PG29	H24B-TG-RO-PG21	T 1 32 024 0121-000	
		H24B-TG-RO-PG29	T 1 32 024 0129-000	
M25 M32	PG21 PG29	H24B-TG-RO-M25	T 1 32 024 0125-000	
		H24B-TG-RO-M32	T 1 32 024 0132-000	
M25 M32 M40	PG21 PG29	H24B-TGH-RO-PG21	T 1 34 024 0121-000	
		H24B-TGH-RO-PG29	T 1 34 024 0129-000	
	M25 M32 M40	PG21 PG29	H24B-TGH-RO-M25	T 1 34 024 0125-000
			H24B-TGH-RO-M32	T 1 34 024 0132-000
			H24B-TGH-RO-M40	T 1 34 024 0140-000
			H24B-TBFH-LB-PG21	T 1 77 024 3121-000
M25 M32	PG21 PG29	H24B-TBF-LB-PG21	T 1 73 024 2121-000	
		H24B-TBF-LB-PG29	T 1 73 024 2129-000	
M25 M32	PG21 PG29	H24B-TBF-LB-M25	T 1 73 024 2125-000	
		H24B-TBF-LB-M32	T 1 73 024 2132-000	
M20 M25 M40	PG21 PG29	H24B-TBFH-LB-PG21	T 1 77 024 3121-000	
		H24B-TBFH-LB-PG29	T 1 77 024 3129-000	
		H24B-TBFH-LB-M25	T 1 77 024 3125-000	
		H24B-TBFH-LB-M32	T 1 77 024 3132-000	
M20 M25 M40	PG21 PG29	H24B-TBFH-LB-M32	T 1 77 024 3132-000	
		H24B-TBFH-LB-M40	T 1 77 024 3140-000	
		H24B-KDTP-LB	T 1 01 024 1500-000	

H24B 带单扣外壳

表面粉末镀层, RAL 7037

外型尺寸 (mm)

外壳底座: 开孔安装

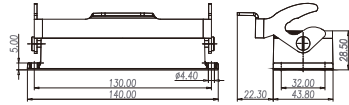

H24B-AG-LB

T 1 50 024 3000-000

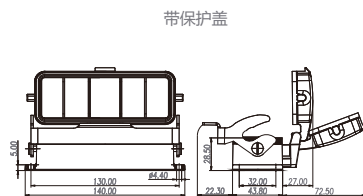

带保护盖

H24B-AD-LB

T 1 51 024 3000-000

外壳底座: 表面安装

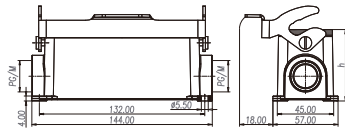

结构	h
低结构	56
高结构	76

低结构
高结构
~ 进线孔
~ 进线孔
~ 进线孔
~ 进线孔

Metr.	PG	型号	订货号
M20	PG16	H24B-SGR-LB-PG16	T 1 61 024 3116-000
M25	PG21	H24B-SGR-LB-PG21	T 1 61 024 3121-000
M20	PG16	H24B-SGR-LB-M20	T 1 61 024 3120-000
M25	PG21	H24B-SGR-LB-M25	T 1 61 024 3125-000
M20	PG16	H24B-SGR-LB-2PG16	T 1 61 024 3216-000
M25	PG21	H24B-SGR-LB-2PG21	T 1 61 024 3221-000
M20	PG16	H24B-SGR-LB-2M20	T 1 61 024 3220-000
M25	PG21	H24B-SGR-LB-2M25	T 1 61 024 3225-000
M25	PG21	H24B-SGRH-LB-PG21	T 1 65 024 3121-000
M32	PG29	H24B-SGRH-LB-PG29	T 1 65 024 3129-000
M25	PG21	H24B-SGRH-LB-M25	T 1 65 024 3125-000
M32	PG21	H24B-SGRH-LB-M32	T 1 65 024 3132-000
M25	PG21	H24B-SGRH-LB-2PG21	T 1 65 024 3221-000
M32	PG29	H24B-SGRH-LB-2PG29	T 1 65 024 3229-000
M25	PG21	H24B-SGRH-LB-2M25	T 1 65 024 3225-000
M32	PG29	H24B-SGRH-LB-2M32	T 1 65 024 3232-000

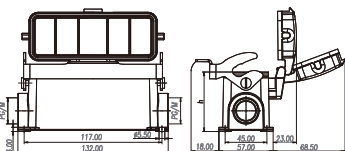

结构	h
低结构	56
高结构	81

低结构
高结构
~ 进线孔
~ 进线孔
~ 进线孔
~ 进线孔

Metr.	PG	型号	订货号
M20	PG16	H24B-SDR-LB-PG16	T 1 62 024 3116-000
M25	PG21	H24B-SDR-LB-PG21	T 1 62 024 3121-000
M20	PG16	H24B-SDR-LB-M20	T 1 62 024 3120-000
M25	PG21	H24B-SDR-LB-M25	T 1 62 024 3125-000
M20	PG16	H24B-SDR-LB-2PG16	T 1 62 024 3216-000
M25	PG21	H24B-SDR-LB-2PG21	T 1 62 024 3221-000
M20	PG16	H24B-SDR-LB-2M20	T 1 62 024 3220-000
M25	PG21	H24B-SDR-LB-2M25	T 1 62 024 3225-000
M25	PG21	H24B-SDRH-LB-PG21	T 1 66 024 3121-000
M32	PG29	H24B-SDRH-LB-PG29	T 1 66 024 3129-000
M25	PG21	H24B-SDRH-LB-M25	T 1 66 024 3125-000
M32	PG21	H24B-SDRH-LB-M32	T 1 66 024 3132-000
M25	PG21	H24B-SDRH-LB-2PG21	T 1 66 024 3221-000
M32	PG29	H24B-SDRH-LB-2PG29	T 1 66 024 3229-000
M25	PG21	H24B-SDRH-LB-2M25	T 1 66 024 3225-000
M32	PG29	H24B-SDRH-LB-2M32	T 1 66 024 3232-000

HD-080 接插体

芯件适配 H32B 外壳

80+  车针
(40x2)

250V 10A

外型尺寸 (mm)

冷压接 (冷压针需单独订购)

接插针排序

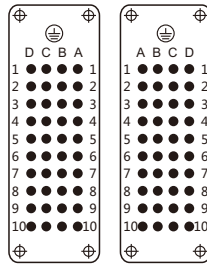

M

F

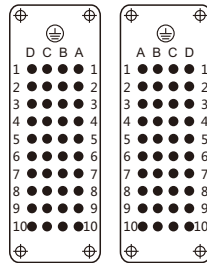

M

F

公接插件	订货号		型号
	母接插件		
T 2 02 040 2101-000 T 2 02 080 2101-000			HD-040-M(1-40) HD-040-M(41-80)
	T 2 02 040 2201-000 T 2 02 080 2201-000		HD-040-F(1-40) HD-040-F(41-80)

插针



接插体之间最大距离24mm

冷压接

线规	剥线长度	镀银冷压接插针		镀金冷压接插针		
		型号	订货号	型号	订货号	
0.14mm ²	AWG26-22	8.0mm	CDM-0.14	T 2 02 000 1002-000	DDM-0.14	T 2 02 001 1002-000
0.5mm ²	AWG20	8.0mm	CDM-0.5	T 2 02 000 1005-000	DDM-0.5	T 2 02 001 1005-000
0.75mm ²	AWG18	8.0mm	CDM-0.75	T 2 02 000 1008-000	DDM-0.75	T 2 02 001 1008-000
1.0mm ²	AWG18	8.0mm	CDM-1.0	T 2 02 000 1010-000	DDM-1.0	T 2 02 001 1010-000
1.5mm ²	AWG16	8.0mm	CDM-1.5	T 2 02 000 1015-000	DDM-1.5	T 2 02 001 1015-000
2.5mm ²	AWG14	6.0mm	CDM-2.5	T 2 02 000 1025-000	DDM-2.5	T 2 02 001 1025-000

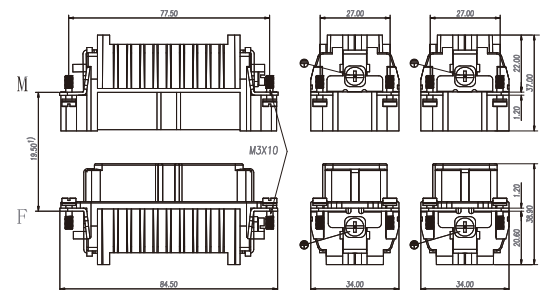

插孔



不使用防护外壳时芯体的安装开孔图

线规	剥线长度	镀银冷压接插针		镀金冷压接插针		
		型号	订货号	型号	订货号	
0.14mm ²	AWG26-22	8.0mm	CDF-0.14	T 2 02 000 2002-000	DDF-0.14	T 2 02 001 2002-000
0.5mm ²	AWG20	8.0mm	CDF-0.5	T 2 02 000 2005-000	DDF-0.5	T 2 02 001 2005-000
0.75mm ²	AWG18	8.0mm	CDF-0.75	T 2 02 000 2008-000	DDF-0.75	T 2 02 001 2008-000
1.0mm ²	AWG18	8.0mm	CDF-1.0	T 2 02 000 2010-000	DDF-1.0	T 2 02 001 2010-000
1.5mm ²	AWG16	8.0mm	CDF-1.5	T 2 02 000 2015-000	DDF-1.5	T 2 02 001 2015-000
2.5mm ²	AWG14	6.0mm	CDF-2.5	T 2 02 000 2025-000	DDF-2.5	T 2 02 001 2025-000

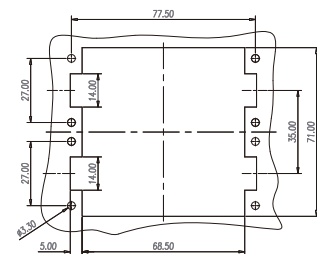

HD-080 接插体

芯件适配 H32B 外壳

80+  冷压针:卷针
(40x2)

250V 10A

外型尺寸 (mm)

卷皮式冷压接 (冷压针需单独订购)

接插针排序

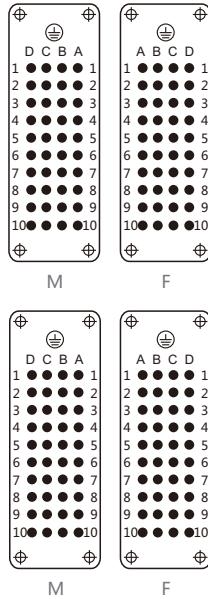
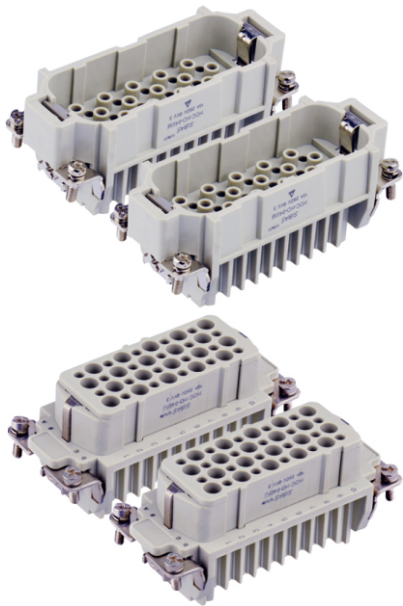

公接插件	订货号		型号
	母接插件		
T 2 02 040 2101-000 T 2 02 080 2101-000			HD-040-M(1-40) HD-040-M(41-80)
	T 2 02 040 2201-100		HD-040-FJ(1-40)
	T 2 02 080 3201-000		HD-040-FJ(41-80)

插针

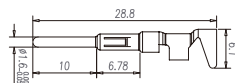

线规	剥线长度	镀银冷压接插针		镀金冷压接插针		
		型号	订货号	型号	订货号	
0.14-0.5mm ²	AWG26-20	4.0mm	CJM-14	T 2 20 000 1005-000	DJM-14	T 2 20 001 1005-000
0.5-1.5mm ²	AWG20-16	4.0mm	CJM-50	T 2 20 000 1010-000	DJM-50	T 2 20 001 1010-000
1.5-2.5mm ²	AWG16-14	4.0mm	CJM-150	T 2 20 000 1025-000	DJM-150	T 2 20 001 1025-000

插孔

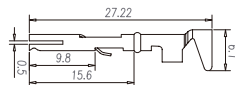

线规	剥线长度	镀银冷压接插针		镀金冷压接插针		
		型号	订货号	型号	订货号	
0.14-0.5mm ²	AWG26-20	4.0mm	CJF-14	T 2 20 000 2005-000	DJF-14	T 2 20 001 2005-000
0.5-1.5mm ²	AWG20-16	4.0mm	CJF-50	T 2 20 000 2010-000	DJF-50	T 2 20 001 2010-000
1.5-2.5mm ²	AWG16-14	4.0mm	CJF-150	T 2 20 000 2025-000	DJF-150	T 2 20 001 2025-000

接插体之间最大距离24mm

冷压接

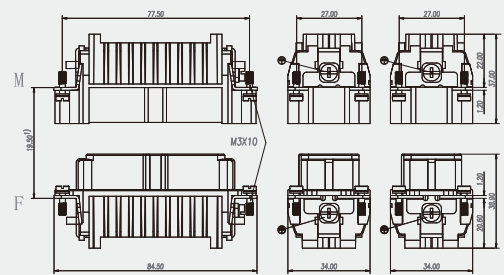

不使用防护外壳时芯体的安装开孔图

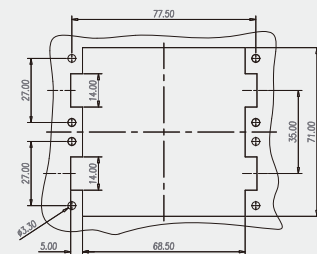

HD-144 接插体

芯件适配 H32B 外壳

144+  车针
(72x2)

250V 10A

外型尺寸 (mm)

冷压接 (冷压针需单独订购)

接插针排序

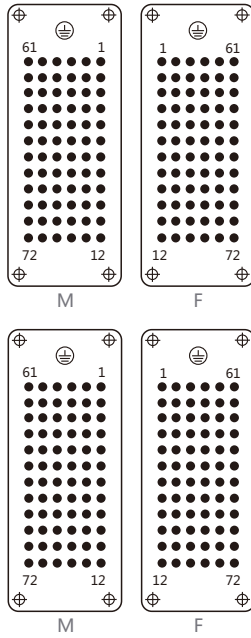
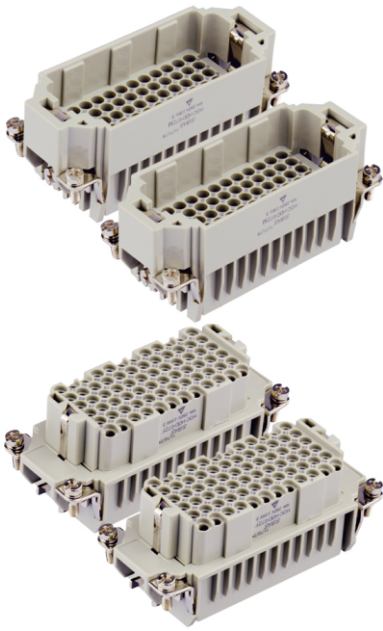

公接插件	订货号		型号
	母接插件		
T 2 03 072 2101-000 T 2 03 144 2101-000			HDD-072-M(1-72) HDD-072-M(73-144)
		T 2 03 072 2201-000 T 2 03 144 2201-000	HDD-072-F(1-72) HDD-072-F(73-144)

插针



线规	剥线长度	镀银冷压接插针		镀金冷压接插针		
		型号	订货号	型号	订货号	
0.14mm ²	AWG26-22	8.0mm	CDM-0.14	T 2 02 000 1002-000	DDM-0.14	T 2 02 001 1002-000
0.5mm ²	AWG20	8.0mm	CDM-0.5	T 2 02 000 1005-000	DDM-0.5	T 2 02 001 1005-000
0.75mm ²	AWG18	8.0mm	CDM-0.75	T 2 02 000 1008-000	DDM-0.75	T 2 02 001 1008-000
1.0mm ²	AWG18	8.0mm	CDM-1.0	T 2 02 000 1010-000	DDM-1.0	T 2 02 001 1010-000
1.5mm ²	AWG16	8.0mm	CDM-1.5	T 2 02 000 1015-000	DDM-1.5	T 2 02 001 1015-000
2.5mm ²	AWG14	6.0mm	CDM-2.5	T 2 02 000 1025-000	DDM-2.5	T 2 02 001 1025-000

插孔



线规	剥线长度	镀银冷压接插针		镀金冷压接插针		
		型号	订货号	型号	订货号	
0.14mm ²	AWG26-22	8.0mm	CDF-0.14	T 2 02 000 2002-000	DDF-0.14	T 2 02 001 2002-000
0.5mm ²	AWG20	8.0mm	CDF-0.5	T 2 02 000 2005-000	DDF-0.5	T 2 02 001 2005-000
0.75mm ²	AWG18	8.0mm	CDF-0.75	T 2 02 000 2008-000	DDF-0.75	T 2 02 001 2008-000
1.0mm ²	AWG18	8.0mm	CDF-1.0	T 2 02 000 2010-000	DDF-1.0	T 2 02 001 2010-000
1.5mm ²	AWG16	8.0mm	CDF-1.5	T 2 02 000 2015-000	DDF-1.5	T 2 02 001 2015-000
2.5mm ²	AWG14	6.0mm	CDF-2.5	T 2 02 000 2025-000	DDF-2.5	T 2 02 001 2025-000

接插体之间最大距离24mm

冷压接

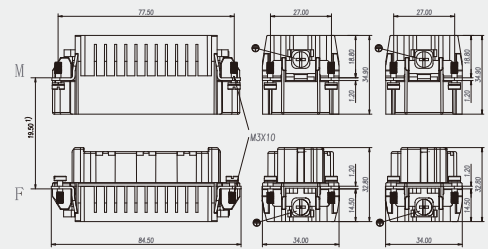

不使用防护外壳时芯体的安装开孔图

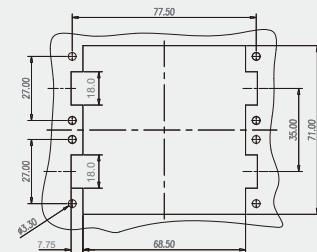





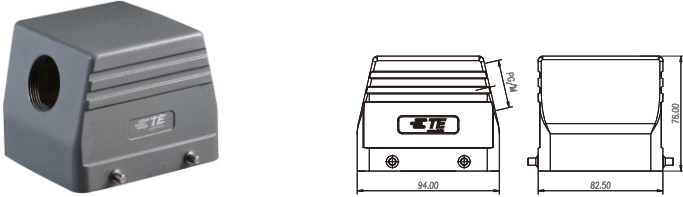
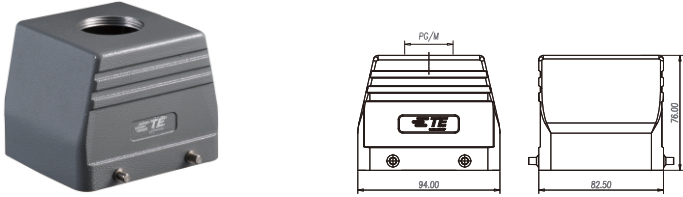
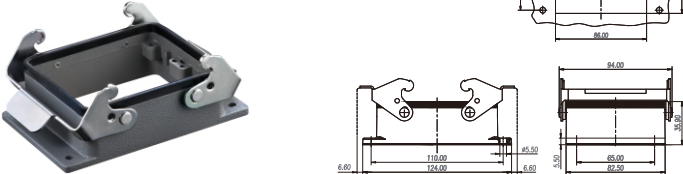
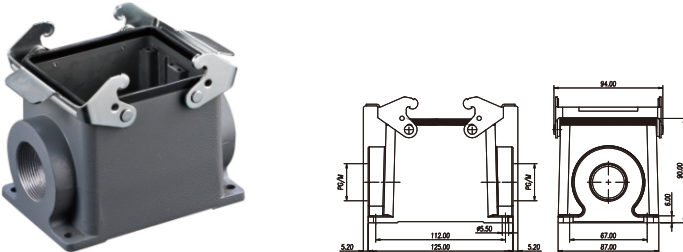
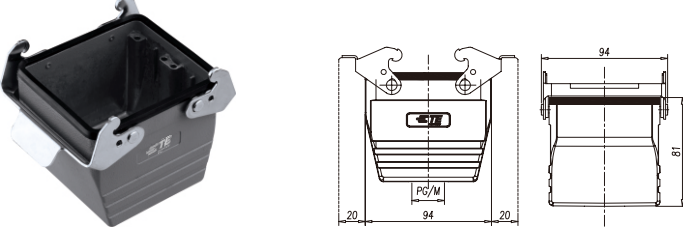
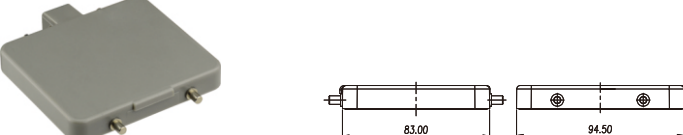



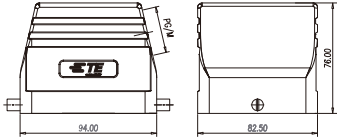

H32B 带双扣外壳

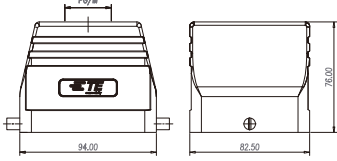
表面粉末镀层, RAL 7037

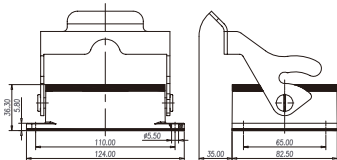
外型尺寸 (mm)	Metr.	PG	型号	订货号
<p>外壳上壳:侧面进线</p> 	M32 M40	PG29 PG36	H32B-TS-PG29 H32B-TS-PG36 H32B-TS-M32 H32B-TS-M40	T 1 21 032 0129-000 T 1 21 032 0136-000 T 1 21 032 0132-000 T 1 21 032 0140-000
<p>外壳上壳:顶部进线</p> 	M25 M32 M40 M50	PG21 PG29 PG36 PG42	H32B-TG-PG21 H32B-TG-PG29 H32B-TG-PG36 H32B-TG-PG42 H32B-TG-M25 H32B-TG-M32 H32B-TG-M40 H32B-TG-M50	T 1 22 032 0121-000 T 1 22 032 0129-000 T 1 22 032 0136-000 T 1 22 032 0142-000 T 1 22 032 0125-000 T 1 22 032 0132-000 T 1 22 032 0140-000 T 1 22 032 0150-000
<p>外壳底座:开孔安装</p> 			H32B-AG	T 1 41 032 2000-000
<p>外壳底座:表面安装</p> 	M32 M40 M50 M63	PG29 PG36 PG42	H32B-SGR-PG29 H32B-SGR-PG36 H32B-SGR-PG42 H32B-SGR-M32 H32B-SGR-M40 H32B-SGR-M50 H32B-SGR-M63	T 1 44 032 2129-000 T 1 44 032 2136-000 T 1 44 032 2142-000 T 1 44 032 2132-000 T 1 44 032 2140-000 T 1 44 032 2150-000 T 1 44 032 2163-000
<p>电缆对接外壳</p> 	M32 M40 M50 M63	PG29 PG36 PG42	H32B-TBF-PG29 H32B-TBF-PG36 H32B-TBF-PG42 H32B-TBF-M32 H32B-TBF-M40 H32B-TBF-M50 H32B-TBF-M63	T 1 71 032 2129-000 T 1 71 032 2136-000 T 1 71 032 2142-000 T 1 71 032 2132-000 T 1 71 032 2140-000 T 1 71 032 2150-000 T 1 71 032 2163-000
<p>下壳保护盖</p> 			H32B-KDB	T 1 00 032 1220-000

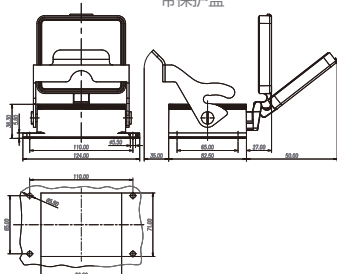
H32B 带单扣外壳

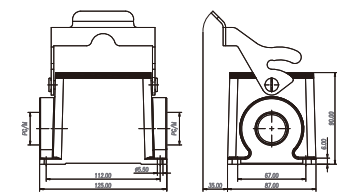
表面粉末镀层, RAL 7037

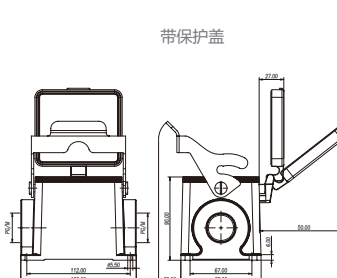
外型尺寸 (mm)	Metr.	PG	型号	订货号
<p>外壳上壳:侧面进线</p>  	M32 M40	PG29 PG36	H32B-TS-RO-PG29 H32B-TS-RO-PG36 H32B-TS-RO-M32 H32B-TS-RO-M40	T 1 31 032 0129-000 T 1 31 032 0136-000 T 1 31 032 0132-000 T 1 31 032 0140-000
<p>外壳上壳:顶部进线</p>  	M25 M32 M40 M50	PG21 PG29 PG36 PG42	H32B-TG-RO-PG21 H32B-TG-RO-PG29 H32B-TG-RO-PG36 H32B-TG-RO-PG42 H32B-TG-RO-M25 H32B-TG-RO-M32 H32B-TG-RO-M40 H32B-TG-RO-M50	T 1 32 032 0121-000 T 1 32 032 0129-000 T 1 32 032 0136-000 T 1 32 032 0142-000 T 1 32 032 0125-000 T 1 32 032 0132-000 T 1 32 032 0140-000 T 1 32 032 0150-000
<p>外壳底座:开孔安装</p>  			H32B-AG-LB	T 1 50 032 2000-000
<p>带保护盖</p>  			H32B-AD-LB	T 1 51 032 2000-000
<p>外壳底座:表面安装</p>  	M32 M40	PG29	H32B-SGR-LB-PG29 H32B-SGR-LB-M32 H32B-SGR-LB-M40	T 1 61 032 2129-000 T 1 61 032 2132-000 T 1 61 032 2140-000
<p>带保护盖</p>  	M32 M40	PG29	H32B-SDR-LB-PG29 H32B-SDR-LB-M32 H32B-SDR-LB-M40	T 1 62 032 0129-000 T 1 62 032 0132-000 T 1 62 032 0140-000
	M32 M40	PG29	H32B-SGR-LB-2PG29 H32B-SGR-LB-2M32 H32B-SGR-LB-2M40	T 1 61 032 2229-000 T 1 61 032 2232-000 T 1 61 032 2240-000
	M32 M40	PG29	H32B-SDR-LB-2PG29 H32B-SDR-LB-2M32 H32B-SDR-LB-2M40	T 1 62 032 0229-000 T 1 62 032 0232-000 T 1 62 032 0240-000

HD-128 接插体

芯件适配 H48B 外壳

128+ Ⓟ 车针
(64x2)

250V 10A

外型尺寸 (mm)

冷压接 (冷压针需单独订购)

接插针排序

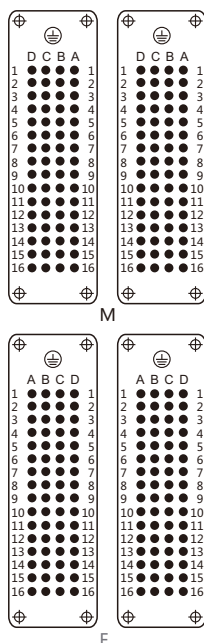
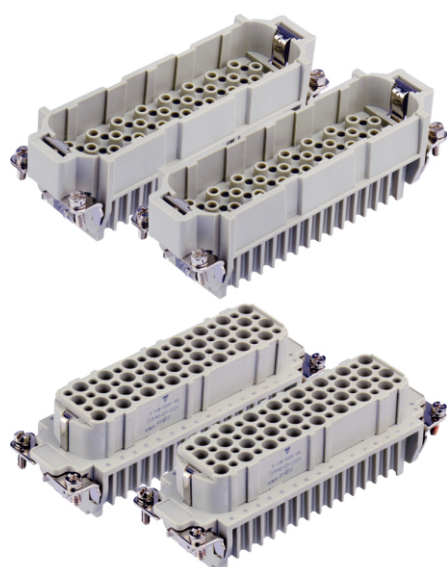

订货号		型号
公接插件	母接插件	
T 2 02 064 2101-000		HD-064-M(1-64)
T 2 02 128 2101-000		HD-064-M(65-128)
	T 2 02 064 3201-000	HD-064-F(1-64)
	T 2 02 128 3201-000	HD-064-F(65-128)

插针

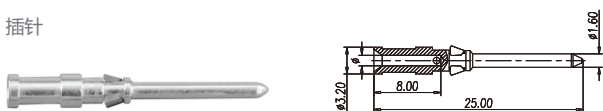

接插体之间最大距离24mm

冷压接

线规	剥线长度	镀银冷压接插针		镀金冷压接插针		
		型号	订货号	型号	订货号	
0.14-0.5mm ²	AWG26-20	4.0mm	CJM-14	T 2 20 000 1005-000	DJM-14	T 2 20 001 1005-000
0.5-1.5mm ²	AWG20-16	4.0mm	CJM-50	T 2 20 000 1010-000	DJM-50	T 2 20 001 1010-000
1.5-2.5mm ²	AWG16-14	4.0mm	CJM-150	T 2 20 000 1025-000	DJM-150	T 2 20 001 1025-000

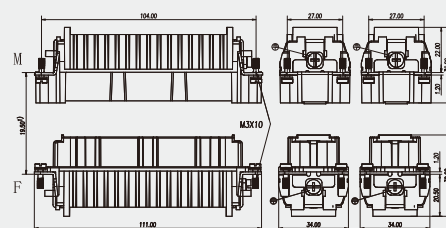

插孔



不使用防护外壳时芯体的安装开孔图

线规	剥线长度	镀银冷压接插针		镀金冷压接插针		
		型号	订货号	型号	订货号	
0.14-0.5mm ²	AWG26-20	4.0mm	CJF-14	T 2 20 000 2005-000	DJF-14	T 2 20 001 2005-000
0.5-1.5mm ²	AWG20-16	4.0mm	CJF-50	T 2 20 000 2010-000	DJF-50	T 2 20 001 2010-000
1.5-2.5mm ²	AWG16-14	4.0mm	CJF-150	T 2 20 000 2025-000	DJF-150	T 2 20 001 2025-000

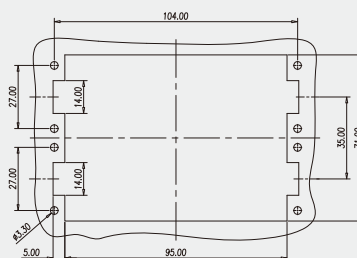

HD-128 接插体

芯件适配 H48B 外壳

128+ Ⓟ 冷压针:卷针
(64x2)

250V 10A

外型尺寸 (mm)

卷皮式冷压接 (冷压针需单独订购)

接插针排序

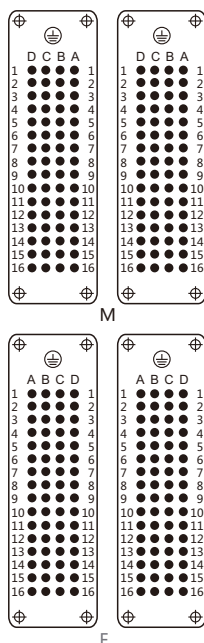
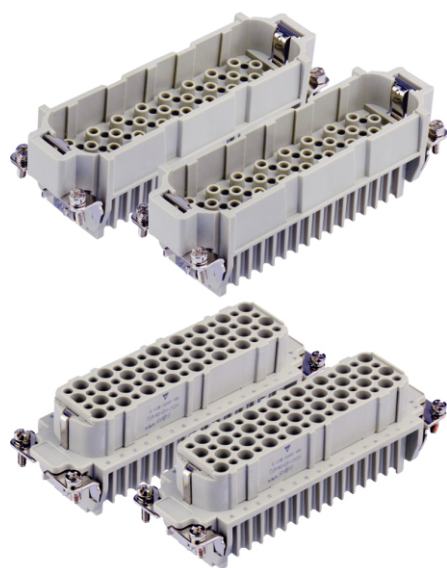

公接插件

订货号

母接插件

型号

T 2 02 064 2101-000
T 2 02 128 2101-000

HD-064-M(1-64)
HD-064-M(65-128)

T 2 02 064 2201-000
T 2 02 128 3201-000

HD-064-FJ(1-64)
HD-064-FJ(65-128)

插针

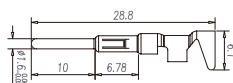

线规	剥线长度	镀银冷压接插针		镀金冷压接插针		
		型号	订货号	型号	订货号	
0.14-0.5mm ²	AWG26-20	4.0mm	CJM-14	T 2 20 000 1005-000	DJM-14	T 2 20 001 1005-000
0.5-1.5mm ²	AWG20-16	4.0mm	CJM-50	T 2 20 000 1010-000	DJM-50	T 2 20 001 1010-000
1.5-2.5mm ²	AWG16-14	4.0mm	CJM-150	T 2 20 000 1025-000	DJM-150	T 2 20 001 1025-000

接插体之间最大距离24mm

冷压接

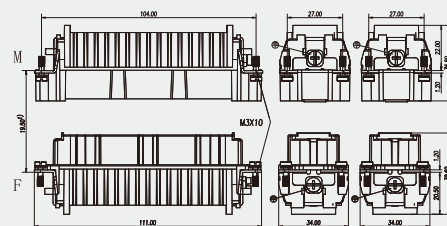

插孔

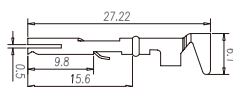

线规	剥线长度	镀银冷压接插针		镀金冷压接插针		
		型号	订货号	型号	订货号	
0.14-0.5mm ²	AWG26-20	4.0mm	CJF-14	T 2 20 000 2005-000	DJF-14	T 2 20 001 2005-000
0.5-1.5mm ²	AWG20-16	4.0mm	CJF-50	T 2 20 000 2010-000	DJF-50	T 2 20 001 2010-000
1.5-2.5mm ²	AWG16-14	4.0mm	CJF-150	T 2 20 000 2025-000	DJF-150	T 2 20 001 2025-000

不使用防护外壳时芯体的安装开孔图

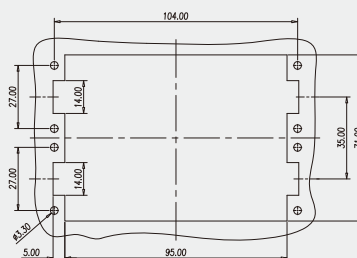

HDD-216 接插体

芯件适配 H48B 外壳

216+ \oplus 车针
(108x2)

250V 10A

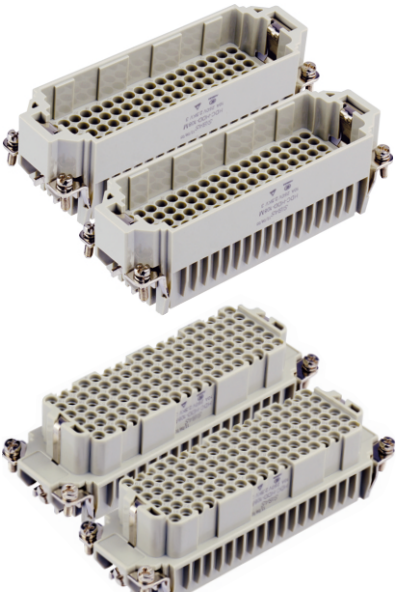
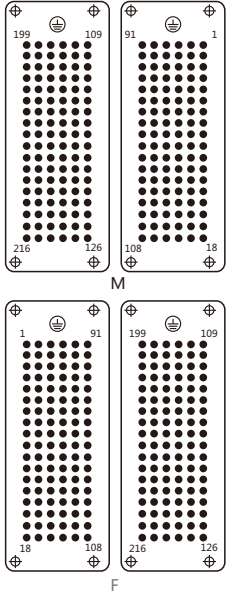
外型尺寸 (mm)	订货号		型号
	公接插件	母接插件	
冷压接 (冷压针需单独订购)	接插针排序		
			
			
	<p>T 2 03 108 2101-000 T 2 03 216 2101-000</p>		<p>HDD-108-M(1-108) HDD-108-M(109-216)</p>
		<p>T 2 03 108 2201-000 T 2 03 216 2201-000</p>	<p>HDD-108-F(1-108) HDD-108-F(109-216)</p>

插针

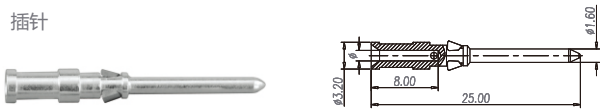

接插体之间最大距离24mm

冷压接

线规	剥线长度	镀银冷压接插针		镀金冷压接插针		
		型号	订货号	型号	订货号	
0.14mm ²	AWG26-22	8.0mm	CDM-0.14	T 2 02 000 1002-000	DDM-0.14	T 2 02 001 1002-000
0.5mm ²	AWG20	8.0mm	CDM-0.5	T 2 02 000 1005-000	DDM-0.5	T 2 02 001 1005-000
0.75mm ²	AWG18	8.0mm	CDM-0.75	T 2 02 000 1008-000	DDM-0.75	T 2 02 001 1008-000
1.0mm ²	AWG18	8.0mm	CDM-1.0	T 2 02 000 1010-000	DDM-1.0	T 2 02 001 1010-000
1.5mm ²	AWG16	8.0mm	CDM-1.5	T 2 02 000 1015-000	DDM-1.5	T 2 02 001 1015-000
2.5mm ²	AWG14	6.0mm	CDM-2.5	T 2 02 000 1025-000	DDM-2.5	T 2 02 001 1025-000

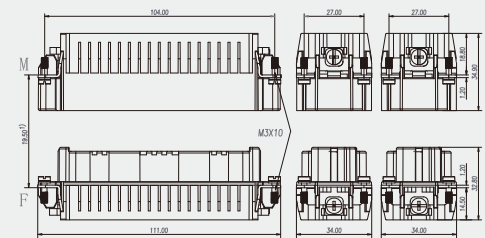

插孔





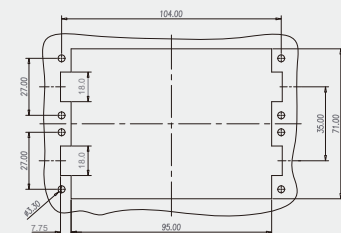





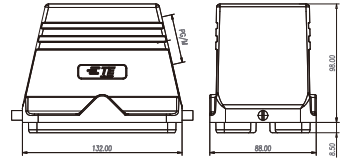

不使用防护外壳时芯体的安装开孔图

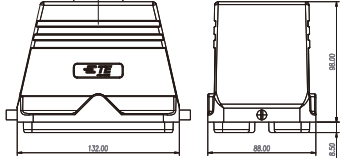

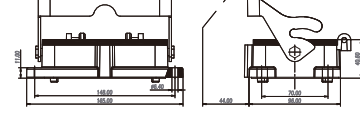
线规	剥线长度	镀银冷压接插针		镀金冷压接插针		
		型号	订货号	型号	订货号	
0.14mm ²	AWG26-22	8.0mm	CDF-0.14	T 2 02 000 2002-000	DDF-0.14	T 2 02 001 2002-000
0.5mm ²	AWG20	8.0mm	CDF-0.5	T 2 02 000 2005-000	DDF-0.5	T 2 02 001 2005-000
0.75mm ²	AWG18	8.0mm	CDF-0.75	T 2 02 000 2008-000	DDF-0.75	T 2 02 001 2008-000
1.0mm ²	AWG18	8.0mm	CDF-1.0	T 2 02 000 2010-000	DDF-1.0	T 2 02 001 2010-000
1.5mm ²	AWG16	8.0mm	CDF-1.5	T 2 02 000 2015-000	DDF-1.5	T 2 02 001 2015-000
2.5mm ²	AWG14	6.0mm	CDF-2.5	T 2 02 000 2025-000	DDF-2.5	T 2 02 001 2025-000

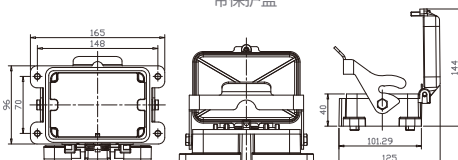
H48B 外壳

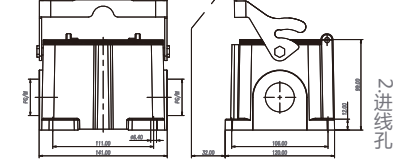
表面粉末镀层, RAL 7037

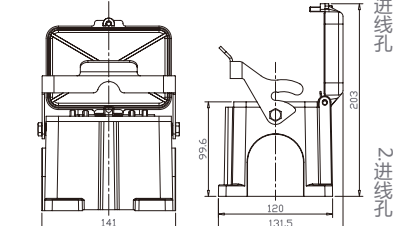
外型尺寸 (mm)	Metr.	PG	型号	订货号
<p>外壳上壳:侧面进线</p>  	M32 M40 M50 M63	PG29 PG36 PG42	H48B-TS-PG29 H48B-TS-PG36 H48B-TS-PG42 H48B-TS-M32 H48B-TS-M40 H48B-TS-M50 H48B-TS-M63	T 1 31 048 0129-000 T 1 31 048 0136-000 T 1 31 048 0142-000 T 1 31 048 0132-000 T 1 31 048 0140-000 T 1 31 048 0150-000 T 1 31 048 0163-000
<p>外壳底座:开孔安装</p>  	M32 M40 M50 M63	PG29 PG36 PG42	H48B-TG-PG29 H48B-TG-PG36 H48B-TG-PG42 H48B-TG-M32 H48B-TG-M40 H48B-TG-M50 H48B-TG-M63	T 1 32 048 0129-000 T 1 32 048 0136-000 T 1 32 048 0142-000 T 1 32 048 0132-000 T 1 32 048 0140-000 T 1 32 048 0150-000 T 1 32 048 0163-000
<p>外壳底座:开孔安装</p>  			H48B-AG	T 1 50 048 2000-000
<p>外壳底座:开孔安装带盖</p>  			H48B-AD-LB	T 1 51 048 2000-000
<p>外壳底座:表面安装</p>  	M32 M40 M50	PG29 PG36 PG42	H48B-SGR-PG29 H48B-SGR-PG36 H48B-SGR-PG42 H48B-SGR-M32 H48B-SGR-M40 H48B-SGR-M50	T 1 61 048 2129-000 T 1 61 048 2136-000 T 1 61 048 2148-000 T 1 61 048 2132-000 T 1 61 048 2140-000 T 1 61 048 2150-000
<p>外壳底座:表面安装带盖</p>  	M32 M40 M50	PG29 PG36 PG42	H48B-SDR-PG29 H48B-SDR-PG36 H48B-SDR-PG42 H48B-SDR-M32 H48B-SDR-M40 H48B-SDR-M50	T 1 62 048 0129-000 T 1 62 048 0136-000 T 1 62 048 0148-000 T 1 62 048 0132-000 T 1 62 048 0140-000 T 1 62 048 0150-000
	M32 M40 M50	PG29 PG36 PG42	H48B-SDR-2PG29 H48B-SDR-2PG36 H48B-SDR-2PG42 H48B-SDR-2M32 H48B-SDR-2M40 H48B-SDR-2M50	T 1 61 048 2229-000 T 1 61 048 2236-000 T 1 61 048 2248-000 T 1 61 048 2232-000 T 1 61 048 2240-000 T 1 61 048 2250-000
	M32 M40 M50	PG29 PG36 PG42	H48B-SDR-2PG29 H48B-SDR-2PG36 H48B-SDR-2PG42 H48B-SDR-2M32 H48B-SDR-2M40 H48B-SDR-2M50	T 1 62 048 0229-000 T 1 62 048 0236-000 T 1 62 048 0248-000 T 1 62 048 0232-000 T 1 62 048 0240-000 T 1 62 048 0250-000

调整后的插针分布

IEC947-1:1988 修订本的表4规定了螺丝连接的拧紧力矩, 以及相应的螺丝类型和规格。本产品目录中产品的技术参数(有别于上述拧紧力矩值)给出了实用的拧紧力矩范围, 使用该范围的力矩可以实现致密、长期稳定的接触连接。

HD D系列 380V~绝缘等级C

500V~绝缘等级C

插针分布图

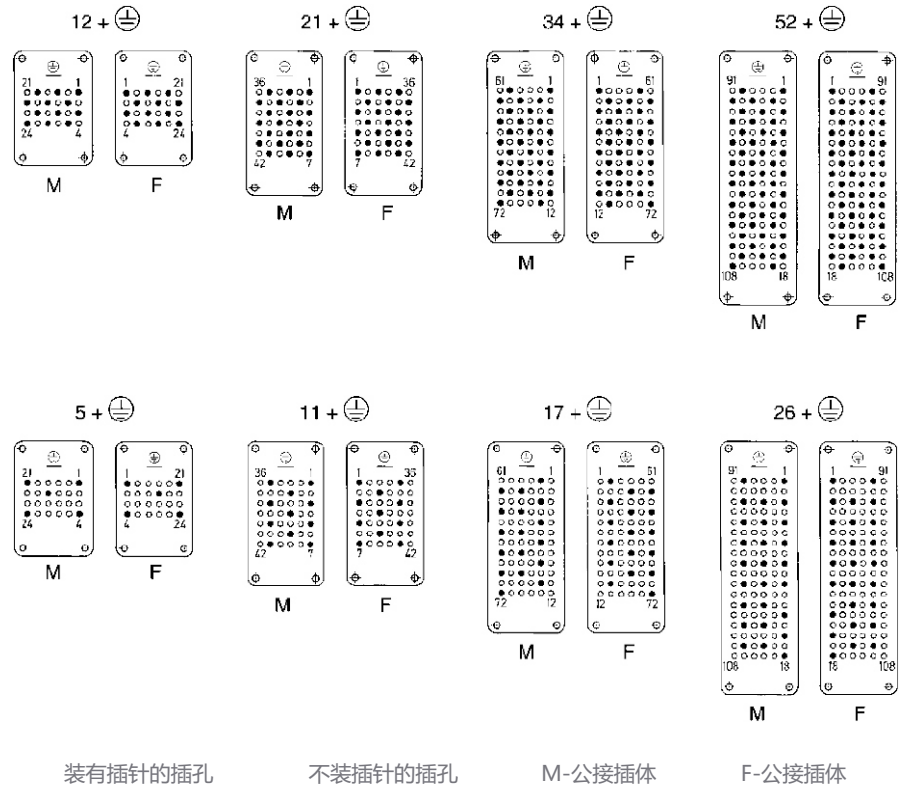

插针分布图

HD系列 500V~污染等级3

